



NORTHERN DIVER
COMMERCIAL DIVING APPAREL & EQUIPMENT
2019 CATALOGUE

Commercial Diving Supplies.
Quality Derived From Passion





Northern Divers range provides versatile solutions for Commercial Divers.

Northern Diver has been designing and manufacturing drysuits and diving products for the Commercial Diving industry for more than three decades, employing cutting-edge designs and technology.

We also offer a personalized online system which can be tailored to your requirements. This allows you to use our online sizing system which will calculate the correct size of suit required by entering measurements (mainly just the height and weight). For a working example of this system visit www.ndiver-commercial.com

Our range is available with a substantial off-the-peg size range plus we offer custom fits.

We can also change neck and wrist seals and boots - This includes a full range of options such as lightweight swimming boots, wide-fitting boots for static commercial diver operations where additional insulation is required, and safety boots with steel toe-caps and mid-sole which conform to EN 345 SAFETY FOOTWEAR STANDARD. There are also additional drysuit custom fit options such as added Kevlar® and Dyneema® protection, additional pockets, hood options, etc. In the event that we need to make an alteration to the suit, this can normally be accomplished for next day delivery.

We can build any drysuit or undersuit to your exact requirements.

Additionally, as part of our commercial diving range we have our own hotwater suits, hotwater boots and hotwater gloves plus our R-Vest, all designed in close consultation with experienced commercial divers and commercial diving organisations.

With our broad range of equipment and excellent customer service we are proud to be supplying various commercial outfits across the globe.





Northern Diver
40 Years Of Innovation

Specialist Contaminated Water.

Thor Drysuit

NSN: N/A

Our Thor drysuit is manufactured from a vulcanised mix of high-grade rubber and EPDM.

Vulcanised laminated polymer sheets are carried on a multidirectional 4-way-stretch knitted polyester, which gives excellent strength and durability.

The Thor is suitable for commercial diving applications but is also an excellent option for military and rescue purposes.

The Thor has been thoroughly tested at the Austin Institute in Texas, USA. All Thor drysuits are CE approved and conform to the latest EEC PPE directive regarding drysuits.

Our quality control management conforms to BS EN ISO 9001:2008, ensuring that all Northern Diver products are of the highest quality and manufacturing standards.

Independent tests show that the Thor drysuit is resistant to chemical permeation. Full details are available on request.

Thor drysuits can be manufactured to custom specifications, including fitting items such as reflective overprinting, extra reinforcement and pockets.

Website.

www.northern-diver-thor.com



Suitable for toxic incidents or water where chemical or biological non-permeability is essential. Suitable also for toxic body recovery.

The drysuit can easily be washed down after use.



THOR 1000G

1000 - THOR - SIZE

S, M, ML, MLR, L, LR, XL, XLR, XXL, XXLR

THOR 1600G

1600G - THOR - SIZE

S, M, ML, L, XL, XXL, XXLR

* Thor suit shown without valves fitted
Left : THOR 1000G Right : THOR 1600G





Specialist Contaminated Water Drysuit. Thor - Options Available

Thor drysuit neck/wrist seals and boots can be changed. This includes a wide range of options, including lightweight swimming boots, wide-fitting boots for static commercial diver operations and safety boots with steel toe caps and mid-sole foil. Neck yokes, additional pockets, dry glove systems and convenience zips are also available.



NECK YOKES

The Thor range of rubber drysuits is compatible with the industry standard diving helmet neck yokes, including Desco, KMB, AH & Genesis models.



BEANIE HOOD

The Beanie Hood offers protection from the cold when wearing with a Latex Hood. Complete with comfortable chin strap.



FIXED CUFF SYSTEM

The Hot Crabber cuff / glove system has excellent resistance to acids, alkalis, abrasion, chemicals, cutting oils and petrol.



LATEX HOOD

Available as a separate item or can be attached to the suit with an optional Beanie Hood. Hood is close fitting - ensures there is no water ingress whilst diving.

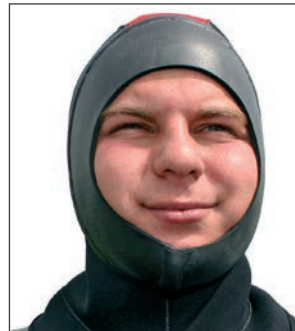

SKIN / SKIN HOOD

Ensures there is a smooth neoprene skin around the face, which will seal when using a full face mask. Skin / Skin Hood works in conjunction with the AGA mask.



DRY GLOVE SYSTEM

For use with both latex and neoprene wrist seals. The unique double-safety locking mechanism gives simple and fast engagement or release, without assistance.

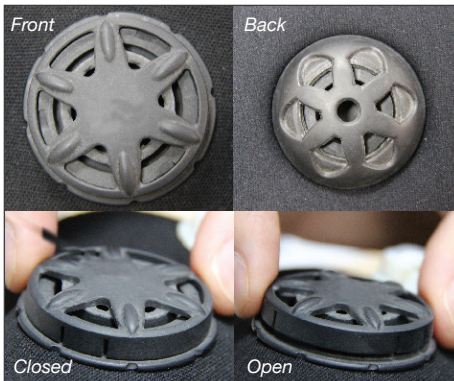

LOCKING CUFF DUMP

A cuff dump with a simple and swift opening/closing operation. It turns 45 degrees from open to closed. It still retains the mushroom silicone seal to stop water ingress when open.



VALVES

Inflation and exhaust valves. These contaminated water valves are specially designed to be chemical, impact and heat resistant.

Sewer and city drain inspection. Neil Tordoff - our Military & Commercial Sales Director with Diver Ltd, Hungary

Thor Boot Options.

Reinforced Safety Boots

Ergonomically designed underwater safety boots, offering chemical and biological penetration protection, plus added impact and sharps penetration resistance.

- 1 EPDM rubber mix pique lining
- 2 Extra EPDM rubber layer
- 3 Neoprene insulation
- 4 Composite toecap
- 5 Rubber sole
- 6 Flexible stainless steel mid-sole foil
- 7 EPDM rubber mix



Boots Supplied.

All toe cap tested to EN 12568 : 2010

Rubber boots come as standard with the 1000G Thor.

Safety boots come as standard with the 1600G Thor.

You can also opt for our overboots. Lead Insoles can be added to these for extra weight and buoyancy control.



SAFETY BOOTS

THOR - BOOT
NSN: N/A

SIZES : 7, 8, 9, 10, 11, 12, 13, 14
Toe Cap Tested To EN 12568: 2010



RUBBER BOOTS

THOR - SOFT - BOOT
NSN: N/A

SIZES : 7, 8, 9, 10, 11, 12, 13, 14
Toe Cap Tested To EN 12568: 2010

Super Large Safety Overboots.

Comfortably fit over any size of Thor boot.



These rugged overboots feature a toe cap which conforms to EN 12568:2010. Mid calf lace up fronts, used in conjunction with the lead soles, make standing underwater easier.

The overboots can also be used with our ISBO fin. Available to buy separately.

LEAD INSOLES

Insoles made from solid lead. Each insole weighs 2.6kg. Available to buy separately.

THOR - OVERBOOT

Thor.
Independent test results show the Thor drysuit is resistant to chemical permeation.



PERMEATION TEST RESULTS			ASTM F739 – 99A	
			AVERAGE NORMALISED	
			BREAKTHROUGH TIME (MIN)	
			0.1 g/cm ² min	
			NORTHERN DIVER THOR	
CHEMICAL	% CON	% MAX	MATERIAL ONLY	MATERIAL SEAM
		WATER		
		SOL.		
ACETONE	10	100	> 480	> 480
ACETONITRILE	10	100	> 480	> 480
AMMONIA SOLUTION	10	100	> 480	> 480
CARBON DISULFIDE	99	0.2	11	6
DICHLOROMETHANE	100	1.3	13	8
DIETHYLAMINE	10	82	> 480	> 480
DIMETHYLFORMAMIDE	10	100	> 480	> 480
ETHYL ACETATE	8.7	8.7	> 480	> 480
HEXANE	0.014	0.014	> 480	> 480
METHANOL	10	100	> 480	> 480
NITROBENZENE	100		7	5
SODIUM HYDROXIDE	10	50	> 480	> 480
SULFURIC ACID	10	100	> 480	> 480
TETRACHLOROETHYLENE	0.015	0.015	246	164
TETRAHYDROFURAN	10	100	127	77
TOLUENE	0.05	0.05	> 480	> 480
ASTM OIL NO.1	10	Not Sol.	> 480	> 480
ASTM OIL NO - 3	10	Not Sol.	> 480	> 480
LIQUID B 70% LSOOCTANE 30%	100	Not Sol.	71	59
LIQUID C 50% LSOOCTANE 50%	100	Not Sol.	59	34

www.ndiver-commercial.com

CHEMICAL PENETRATION TESTS

The majority of divers using Thor drysuits in contaminated water require information regarding the drysuit’s protective qualities to be made available. Thor suits underwent permeation testing under worst case scenario conditions – 100% chemical exposure for the entire length of the test.

Although these test conditions are unlikely in any chemical diving environment, the results demonstrate the protection offered under most normal circumstances.

PERMEATION TEST RESULTS

The permeation values are based on the time it takes for the chemical to permeate the suit material. The permeation test is performed up to 480 minutes. The reports that indicate greater than 480 minutes means that no chemical was detected above 0.1 mg/min/cm² for 8 hours’ duration.

ACTUAL BREAKTHROUGH VS NORMALISED BREAKTHROUGH

Actual breakthrough is reported in minutes and occurs when initial breakthrough is detected. Each chemical tested has unique characteristics and minimal detectable limits. For example: if a chemical has a minimum detectable limit of 0.059 mg/min/cm², actual

breakthrough is reported when challenge chemical concentrations reach 0.059 mg/min/ cm² or greater. Normalised breakthrough occurs when challenge chemical breakthrough concentrations reach 0.1 mg/min/ cm² or greater (AaSTMm Ff739).

MAXIMUM AND MINIMAL DETECTABLE RATES

This indicates the maximum level of chemical detection using the permeation test system. The minimal detectable rate is the lowest rate of permeation that is detectable with the permeation system.

STEADY STATE PERMEATION

The constant rate of permeation that occurs after breakthrough when the chemical contact is continuous and all forces affecting permeation has reached equilibrium.

WHEN DIVING IN POLLUTED, CONTAMINATED OR GENERALLY ABNORMAL ENVIRONMENTS

Northern Diver’s Thor drysuit has been developed and tested for use in these conditions and as such should be regarded as an integral component of your diving plans. Diving in contaminated environments has the potential to be extremely dangerous.

All information supplied within this brochure is intended purely for informative purposes only. It is not a substitute for proper training and should not be regarded as so. The information in the brochure is not a substitute for applicable regulations or standards and is not published as legal advice or opinion in any way. Thor drysuits have been tested to standard EN 14225-2:2005.

DECONTAMINATION

After exposure to a contaminated environment, the Thor drysuit must be decontaminated, ensuring that all contaminants have been removed from the drysuit.

Diving in contaminated environments should not be undertaken by those without the appropriate level of training. All risks should be understood prior to any contaminated environment diving, with all risks carefully planned for and the utmost care taken.

Follow Link.



Hotwater Saturation Diving Suit.

Evolution 8

Our Hotwater Suit has been developed over the last 30 years. It has been tested under the UK Balmoral platform in the North Sea, at a depth of 350 metres. It is trusted by commercial divers and schools around the world.

The ergonomically designed suit is based around our unique heavy anodised water distribution valve, which includes a 360° stainless steel swivel connector. The water flows through an anti-kink flat rubber pipe system, with the flow rate controlled by the diver. The pipes are directed for comfort and have padded neoprene covers – perfect for those long bell runs. When the water distribution valve is not feeding the suit, it dumps to the rear. This function is selected via a control knob.

There's a handy eyelet on the front of the chest which houses a hot water pipe (inc plug). This can be used to heat the diver's faceplate to improve visibility.

The suit body is manufactured from specially developed anti-shrink neoprene with a high rubber solids content and a durable Swiss pique outer lining.

Tested to BS EN 14225-3:2005 by an independent notified body. Full size range in stock and available for immediate delivery.

Also Available.

Denim Hotwater



HWS - DENIM - SIZE

Used In Depths Up To 350 Meters
& Tested by Industry for 30 years



HOTWATER SUIT

CODE : HWS1899 - SIZE

S, M, ML, MT, L, LT, XL, XLT, XXL,
XXLT, XXXL



Helmet photographed supplied by Kirby Morgan Dive Systems, Inc.

Features.

CE Approved Saturation Diving Suit

Our Hotwater Suit system conforms with the provisions of Council Directive 89/686/EEC and BS EN 14225 - 3 - 2005

- ✓ Diver climate control system
- ✓ Specially developed anti-shrink neoprene
- ✓ Anodised aluminium water distribution valve with 360° stainless steel swivel connector
- ✓ Flat pipe technology - for additional comfort and a improved flow rate of 20%
- ✓ Eyelet with pipe (inc plug) for faceplate clearing
- ✓ Heavy duty YKK Vislon® zip with securing tab
- ✓ Zipped ankles with securing tabs
- ✓ Wrap-around neoprene neck with soft lining
- ✓ Removable Velcro ID badge on chest
- ✓ Removable Velcro reflective strips on upper arms
- ✓ 2 bellows pockets with drain holes and equipment attachment eyelets
- ✓ Right pocket features 80mm blade knife with attachment lanyard (not supplied if exported)
- ✓ Pre-bent polymer-reinforced knee patches
- ✓ Polymer embossing which circles the legs in the calf area, useful for duct taping boots or socks to the suit if the diver wishes to do this – same embossing can be found around the arm for use with gloves
- ✓ Wrist area has two pieces of diagonal Velcro for glove attachment
- ✓ Shoulder harness retaining epaulettes
- ✓ Supplied with a 1/4" in-line double barb plastic connector

Hotwater Valve.

Anodised Aluminium Water Distribution Valve

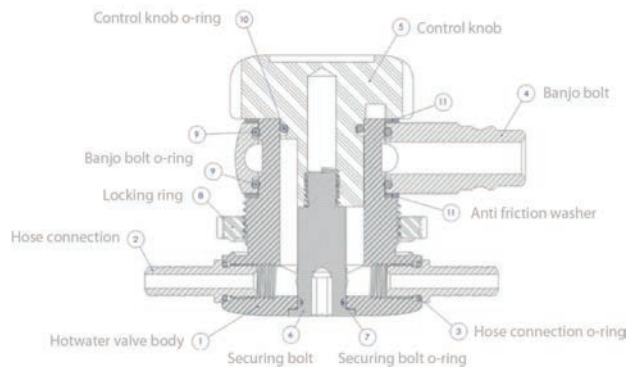

Our Hotwater Valve

Designed to distribute water around the hot water suit. The inlet source (hot water) is connected to the banjo bolt which is controlled via the control knob.

When the control knob is switched to the suit position the hot water feeds the six outlet positions which connect to the internal suit tubing.

Moving the control knob to the dump position diverts the water inlet to atmosphere.

Hotwater Manifold Configuration

The first part of the pipe that runs from the manifold is recognised as an area which would normally require regular maintenance. Northern Divers manifold uses a medium pressure hose, which is anti-kink to EN250, to prevent the hose from breaking at the manifold.

The hose is attached to the manifold using crimped 316 stainless steel ferral's which ensure the hose does not pull away from the manifold. Pull tested to 100kgs.

The remaining pipe that runs throughout the suit uses Northern Divers specially developed flat pipe technology, to ensure the diver stays comfortable.

The result

The diver stays warm and comfortable. The technician has minimal work to carry out. The purchaser saves costs over the lifetime of the suit.



Heavy Duty. Denim Hotwater

Manufactured from heavy duty denim, and including double stitched seams, the Denim Hotwater has a condensed pipe circuit (non-flat) and a looser fit than its neoprene counterpart.

The suit has the same anodised aluminium water distribution valve.

The pipe circuit covers the back, legs and arms of the suit.

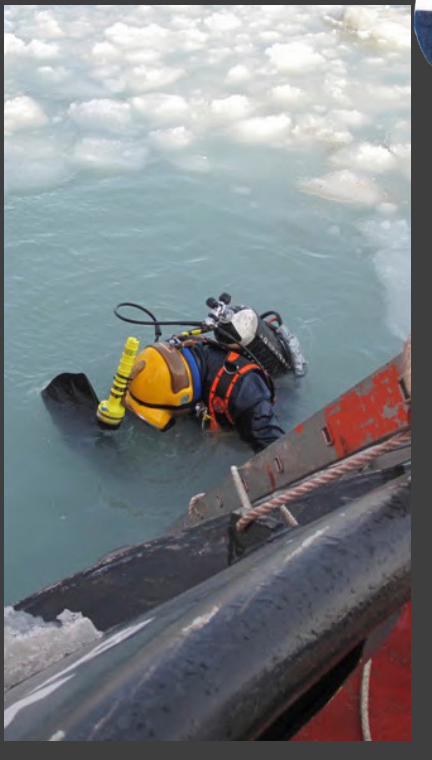

Features.

Hard-wearing denim build

Adjustable Velcro straps on wrists and ankles

2 large bellows pockets with drainage holes

Reflective strips on both upper arms

DENIM HOTWATER SUIT

HWS - DENIM - SIZE

S, M, ML, L, LT, XL, XXL

Also Available. Service Kit

A service kit for the Hotwater manifold. The manifold should be serviced every 3-6 months, or yearly if used less than once a year.



HWS - SERVICE KIT
NSN: N/A



Helmet photographed supplied by Kirby Morgan Dive Systems, Inc.

Neoprene.

Hotwater Wetsuit

Also worn by commercial divers under our Hot Water Suit, this suit doubles as a 3mm super-stretch neoprene wetsuit, suitable for more temperate diving environments.

Our Hotwater Wetsuit has proved itself to be an incredibly versatile product. It is used not only by the diving community, but also in many other in-water situations where keeping warm is essential.

Many sport divers are now using their Hotwater Wetsuit as an additional layer of insulation beneath their drysuits. It has proved useful for those who want to perform deeper dives or dive in colder waters.

Jonathan Warburton, Trade & Commercial Sales, at The Underwater Centre, Fort William

www.ndiver-commercial.com



Thermal Skin.

Bodyline Undersuit

NSN: 4420 - 99 - 907 - 1034

The 3mm neoprene bodyline undersuit can be worn in conjunction with both neoprene and denim hotwater suits.

See **page 36-37** for more details

HOTWATER UNDERSUIT

CODE : HWS - WETSUIT - SIZE

S, M, L, XL, XXL

1000kg.

R-Vest

With an overall breaking strength of 1000kg, the Northern Diver R-Vest surpasses the requirements set by the Association of Diving Contractors International.

The R-Vest is built for the most demanding of conditions and is manufactured in line with the International Consensus Standards for Commercial Diving and Underwater Operations.

Features.

- Manufactured and tested in accordance with ADCI guidelines
- Each of the 9 D-rings has been independently tested to a breaking strength of 1000kg
- Quick release sat bag for carrying tools
- Loop on the left/right side for carrying hammer
- Backpack with cam band for attaching cylinders
- Adjustable waist and crotch straps
- Quick release weight pocket



R-vest pockets available to buy separately.

R-VEST POCKETS

STANDARD & XL

R-VEST B/P - SIZE



R-vest sat bag available to buy separately.

SAT BAG-ND (or) SAT BAG-NO LOGO

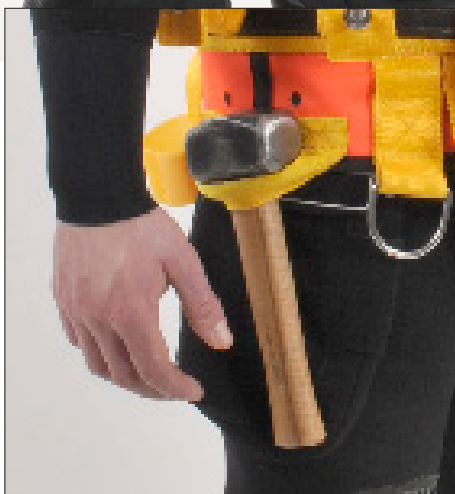



R - Vest Harness.

XL Sizes Only

The Northern Diver R-Vest harness is manufactured from ultra-durable materials which give maximum comfort and is able to withstand the rigours of commercial diving. The R-Vest distributes loads evenly over the body and features quick release weight pockets.

There are three recovery points (one on each shoulder, and one centre back this ensures that the diver may be rescued in the event of an injury. The R-Vest complies with the relevant requirements of EN 250 2000.

The photo (left) shows a R-Vest with optional lace-up cylinder bag and attached lead weights. The photo below it shows a R-Vest with optional cylinder back pack. Our standard size fits a 36"-46" chest and our extra large size fits a 48"-64" chest.

R-VEST - SIZE

XL

Bell / Safety.

Harness

A diver recovery harness utilising heavy duty webbing and large stainless steel D-rings, ergonomically designed for comfort and safety.

There is a lifting point at the back of the divers neck and chest mounted D-rings for tool and umbilical attachments.

The yellow harness features a waist strap adjustment with a cam type buckle and adjustable leg straps. The shoulder and chest straps are also fully adjustable.



COMMERCIAL DIVING BELL HARNESS

ONE SIZE

Neoprene Drysuit.

Origin

Origin Commercial is the developed version of Northern Diver's original neoprene drysuit.

It is incredibly popular with experienced divers around the world and remains a preferred choice of commercial divers.

This drysuit is ideal for advanced 'non-commercial' divers who regularly plan dives with little physical movement, long duration or extended deco stops.

The Origin is manufactured from 6.5mm neoprene, with a tough Armatex® outer shell and our Ti-Ax® Thermacote® heat reflective lining system.

It also features Kevlar® elbow, shoulder and knee protection, ensuring it will withstand years of action.

This drysuit's sizes are a wider fit than our standard drysuit sizes, allowing any combination of our undersuits to be used and covering all diving conditions.

The Origin is available off-the-peg with durable hard sole boots or steel toe and mid-sole foil safety boots. The safety boots conform to safety boot standard EN12568/98.



The Origin is a proven no-nonsense Drysuit

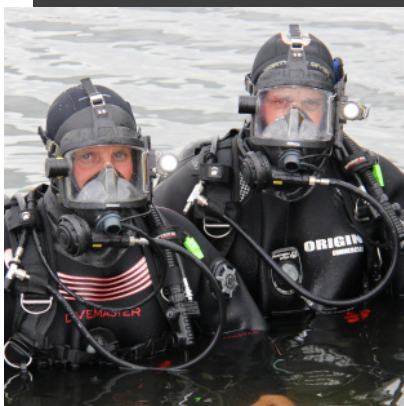

ORIGINCG - SIZE

UNISEX: M, ML, L, XL, XLT, XXL, XXXL & MTM



Helmet photographed supplied by Kirby Morgan Dive Systems, Inc.



Origin in use by the Royal Navy in the Falklands



Origin Commercial
Norfolk Fire & Rescue Service

Origin Features.

- 6.5mm neoprene
- Rear entry heavy duty BDM metal zip with protective flap
- Neoprene neck and wrist seals
- Northern Diver low profile inflation and exhaust valves, located in standard positions
- 'Bonded for life' seams
- Liquid taped outside seams
- Zipped transporter pockets on thighs, left pocket fitted with external stainless steel D-ring
- Kevlar® protection on shoulders, elbows and knees
- Overprinted seat area for non slip grip and abrasion protection
- Fitted with durable hard sole boots
- Supplied with neoprene hood, storage bag (folds out for use as a changing mat) and a maintenance repair kit.

WHATS IN THE BOX?





Fitted drysuit valves, standard hose and a drysuit maintenance kit



A hood with printing to match your suit & storage bag/changing mat

NORTHERN DIVER DRYSUITS

-  All Northern Diver drysuits are tested to a Military standard & conform to **BSEN ISO 14225 - 2 : 2005**.
- Custom tailoring** is available for all stock drysuits. With a few decades of experience our repairs and alterations department has your suit in safe hands. Check out how you can customise your suit - **page 27**
-  A drysuit manual is available to download online at www.ndiver.com/pages/Downloads

RECOMMENDED UNDERSUITS



 **THERMALSKIN** The Bodyline/Thermal Skin can be worn in conjunction with any of the above undersuits for more extreme environments or simply for extra warmth.

Divemaster.

Commercial Edition

The Divemaster is the first choice of active sport divers and the UK's major commercial diving schools. Manufactured from a specially formulated 5mm hyper-compressed neoprene, the Divemaster allows freedom of movement and real diving flexibility, as well as being exceptionally hard-wearing.

Hyper-compressed is not just a name to increase product appeal. This is a full commercial process, requiring the use of a 500 ton heated press. Although this may sound excessive, this is a necessary process to achieve the highest possible standards in neoprene manufacturing.

The Divemaster can be used in conjunction with any undersuit in our range, for example the Thermalux® in mild European waters or Metalux® Temperate for more extreme diving conditions).

The Divemaster gives the user a comfortable environment when diving and can be pitted against the harshest of diving scenarios, such as ice diving and long duration cold water diving. Durability is increased by the heavy-duty pique nylon outer shell. Our unique Ti-Ax® Thermacote® heat reflecting system is under the inner lining inside the drysuit. With a host of premium features as standard, this drysuit really is a leader in reliability.

Available as a perfectly fitting made-to-measure suit, but with standard off-the-peg sizes, most divers will be able to make an instant splash.



EVOLUTION 12

A Tradition That Has Just Evolved . . .



DIVE - COM - SIZE

UNISEX: S, M, ML, MLR, MLT, MR, L, LR, LT, XL, XLR, XLT, XXL, XXLR, XXLT, XXXL, XXXLR & MTM



Divemaster Features.

- Hyper-compressed neoprene
- 'Bonded for life' seams
- Rear entry BDM metal zip with protective flap
- Neoprene neck and wrist seals
- Northern Diver low profile Inflation and exhaust valves, located in standard positions
- Bellows pocket on right thigh
- Zipped transporter pocket on left thigh
- Kevlar® kneepads
- Fitted with durable hard sole boots
- Supplied with neoprene hood, storage bag (folds out for use as a changing mat) and a maintenance repair kit.



WHAT'S IN THE BOX?



Fitted drysuit valves, standard hose and a drysuit maintenance kit



A hood with printing to match your suit & storage bag/changing mat

NORTHERN DIVER DRYSUITS



All Northern Diver drysuits are tested to a Military standard & conform to **BSEN ISO 14225 - 2 : 2005**.

Custom tailoring is available for all stock drysuits. With a few decades of experience our repairs and alterations department has your suit in safe hands.

Check out how you can customise your suit - **page 27**



A drysuit manual is available to download online at www.ndiver.com/pages/Downloads

RECOMMENDED UNDERSUITS

THERMALUX

METALUX
TEMPERATE

THERMICORE

THERMALSKIN

The Bodyline/Thermal Skin can be worn in conjunction with any of the above undersuits for more extreme environments or simply for extra warmth.

Divemaster Commercial 12 - The Underwater Centre
*Helmet photographed supplied by Kirby Morgan Dive Systems, Inc

Tri-laminate Drysuit.

Cortex Black

All British military divers undergo their initial training in this drysuit, a military black version of our Cortex sports drysuit.

The British Ministry of Defence trains divers to an exceptionally high standard. As well as undertaking complex diving tasks as part of their training, trainees must also pass a physical fitness test. This includes a long distance swim and mud run, with the drysuit worn for both exercises.

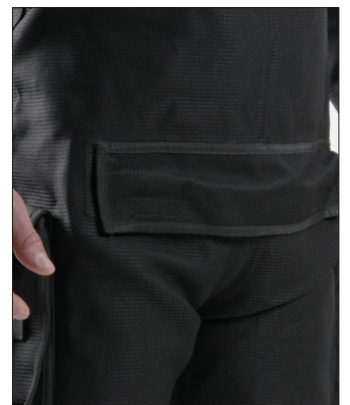
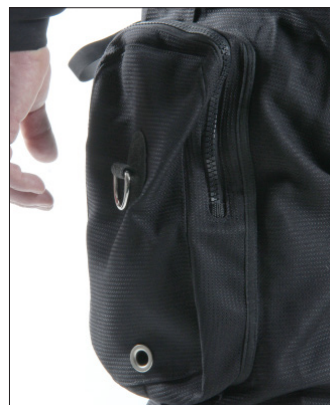

CORTEX - BLACK - SIZE

UNISEX: S, M, ML, MLR, MLT, MR, L, LR, XL, XLR, XLT, XXL, XXLR, XXXL & MTM



Our Cortex being used on an induction course for future Military Divers
Defence Diving School, Horsea Island



Cortex Black Features.

- Ultra-durable Cortex fabric
- Triple glued, rubber taped seams
- Rear entry heavy duty BDM metal dry zip with protective cover
- Adjustable elasticated internal braces
- Fly zip with protective cover
- Low profile inflation and variable exhaust valves on the centre of the chest and left wrist respectively
- Neoprene neck seal and latex wrist seals with neoprene warmers
- Kevlar® kneepads with protective overprinting
- Bellows pocket with integrated knife pocket on right thigh
- Zipped transporter pocket on left thigh
- Max grip durable hard sole boots
- Supplied with neoprene hood, storage bag (folds out for use as a changing mat) and a maintenance repair kit.

WHATS IN THE BOX?



Fitted drysuit valves, standard hose and a drysuit maintenance kit



A hood with printing to match your suit & storage bag/changing mat

NORTHERN DIVER DRYSUITS



All Northern Diver drysuits are tested to a Military standard & conform to **BSEN ISO 14225 - 2 : 2005**.

Custom tailoring is available for all stock drysuits. With a few decades of experience our repairs and alterations department has your suit in safe hands. Check out how you can customise your suit - **page 27**



A drysuit manual is available to download online at www.ndiver.com/pages/Downloads

RECOMMENDED UNDERSUITS

THERMICORE

THERMICORE

METALUX
TEMPERATE

METALUX
ARCTIC

THERMALSKIN

The Bodyline/Thermal Skin can be worn in conjunction with any of the above undersuits for more extreme environments or simply for extra warmth.



TOUGH ENOUGH?

We think so, which is why Northern Diver CORTEX SUITS have been chosen for such intense use.

See the suits in action:
www.youtube.com/watch?v=lgTORJ_DYPE

Technical Drysuit.

HID

The HID is manufactured from ultra hard-wearing black Aquatex fabric. Don't expect a considerable amount of excess material, a usual feature of a membrane drysuit, as the Constant Fit Tension Flex system on our technical tri-laminate drysuit fits closely whilst moving in tune with the diver's body. This system, located at the waist of the drysuit, is a fold of the drysuit's material that extends and retracts as the diver's movements dictate. Should the diver kneel down, reach high, reach back or simply bend forwards, the HID will move effortlessly with them. A removable crotch strap is also included.

As the HID is front-entry, the Constant Fit Tension Flex system comes in handy when putting on and removing the drysuit; when completing these processes, the YKK high-compression Aquaseal zip is not put under excessive pressure, nor the diver's neck.

The HID has some very useful features. With items such as a dive computer in mind, we have added our recently developed Anti Slip Equipment Anchor to each wrist. Owing to the anti-slip material used, the anchor helps to keep your equipment secure and in position for the duration of the dive.

There is also a pocket for our popular new Flexi-Light just below the shoulder on the side of the left arm.

The HID has a zipped transporter pocket, with an integrated diver's knife pocket, on the side of the right thigh. In the same position on the left thigh, there is a Velcro bellows pocket. If you're a technical or wreck diver carrying specialist diving equipment, or just like to have generous drysuit pockets, the HID has it covered.



YKK
Little Parts. Big Difference.

4-WAY
SUPERSTRETCH
NEOPRENE

TÜV Rheinland



Do you dive where
others dare not?



HID - SIZE

UNISEX: S, M, ML, MR, MLR, MLT, L, LR, XL, XLR, XLT, XXL, XXLR, XXXL & MTM



Please note: Digital Depth Gauge is sold separately. The ASEA can be used with any wrist mounted dive computer. It has been fitted to both arms, complete with over printing for a non-slip surface to keep your equipment securely in place.

LED. Flexi Lights



High intensity LED that projects light through a flexible silicone stick. The Flexi-Light has a simple press-to-operate button under the coloured marker, which activates flashing, constant and off modes. For use with the Flexi-light stick pocket on the suits arm.



Accessories. Knives



Photos opposite show HID pocket with a non magnetic MoD Alpha Titanium knife housed inside.

Available to buy separately.

HID Features.

- Black Aquatex tri-laminate fabric
- Constant Fit Tension Flex system
- 'Bonded for life' seams
- Front entry YKK high compression Aquaseal zip
- Neoprene neck seal (with neoprene warmer) and latex wrist seals
- Northern Diver low profile Inflation and exhaust valves, located in standard positions
- Zipped transporter pocket (with integrated knife pocket) on right thigh
- Bellows pocket on left thigh
- Flexi-Light stick pocket on right upper arm
- Adjustable and removable crotch strap
- Kevlar® kneepads
- Fitted with durable hard sole boots
- Supplied with neoprene hood, storage bag (folds out for use as a changing mat) and a maintenance repair kit.

WHATS IN THE BOX?



Fitted drysuit valves, standard hose and a drysuit maintenance kit



A hood with printing to match your suit & storage bag/changing mat

NORTHERN DIVER DRYSUITS



All Northern Diver drysuits are tested to a Military standard & conform to **BSEN ISO 14225 - 2 : 2005**.

Custom tailoring is available for all stock drysuits. With a few decades of experience our repairs and alterations department has your suit in safe hands. Check out how you can customise your suit - **page 27**



A drysuit manual is available to download online at www.ndiver.com/pages/Downloads

RECOMMENDED UNDERSUITS

THERMICORE

THERMICORE

METALUX
TEMPERATE

METALUX
ARCTIC

THERMALSKIN

The Bodyline/Thermal Skin can be worn in conjunction with any of the above undersuits for more extreme environments or simply for extra warmth.

Your Specification. Our Expertise

Build a suit to your specific requirements.

Each drysuit is made up of parts that can be swapped and changed to suit your needs.

There is a range of options available to ensure your drysuit works effortlessly with you in your environment.

If you do not see what you are looking for, please contact us. We can normally help to develop and manufacture most requests.

Call us: +44 (0) 1257 25 44 44

Email : info@ndiver.com

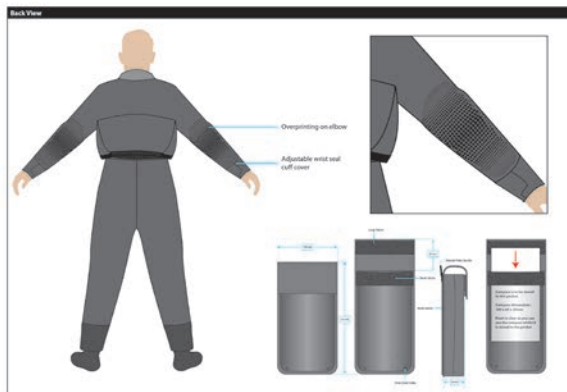
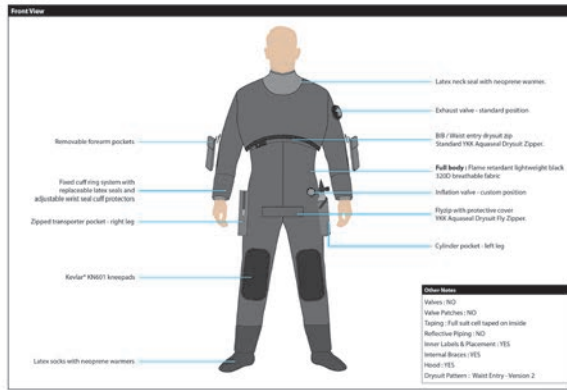

Options include but are not limited to:

- Hoods
- Neck seals
- Neck warmers and collars
- Suit fabrics
- Wrist seals and cuff protectors
- Arm, chest, leg and pockets
- Rear, BIB and front entry zips
- YKK plastic and BDM metal zips
- Zip protection covers
- Removable badges
- Shoulder, elbow, seat, knee, crotch and inner leg reinforced protection
- Suit socks
- Suit boots

210D & 320D. Embratex Tri-Laminate

320D fully breathable embratex cotton feel nylon with water repellent coating.

Tested to - EN ISO 14225-2:2005 for sea water resistance and EN ISO 15027-1:2002 for materials, fabrics and components, fire resistance, temperature cycling, leakage, performance, dexterity & mobility. Using the Test Methods specified in EN ISO 15027-3:2002

FABRIC-BE-210 or FABRIC-BE-320

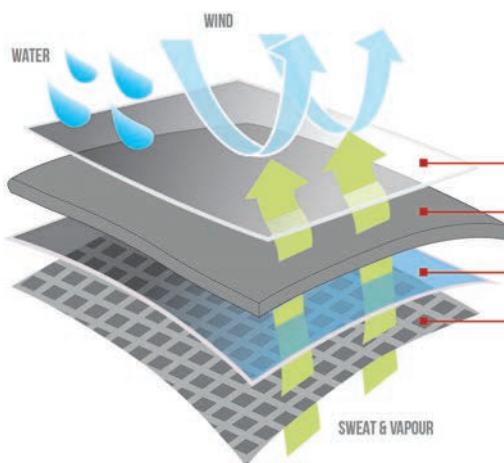

DURABLE WATER REPELLENT SPRAY [DWR]

TASLON NYLON

POLYURETHANE MEMBRANE [PU]

TRICOT MESH LINING



450D. Aquatex Tri-Laminate

The tightly woven face fabric is proven to be incredibly resistant to abrasion and tearing. In addition to its strength, Aquatex is very comfortable, proving a popular choice for boat handlers and personnel who wear their suits for many long hours at a time.

Butyl Rubber is sandwiched between two layers of polyester to create a durable and flexible fabric

FABRIC-AQT

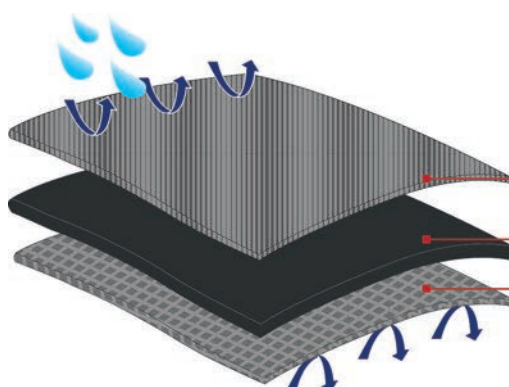

TEXTURED TWILL POLYESTER

BUTYL RUBBER

POLYESTER TAFFETA



500D.

Cortex Tri-Laminate

Renowned for its hard-wearing abilities, Cortex resists scuff and scrapes with its strong Cordura® outer layer. Cortex is often chosen for drysuits when a stronger body is required.

Cortex also offers unsurpassed durability and tear resistance and is an ideal choice for technical divers and divers who appreciate quality construction and performance.

FABRIC-CCH

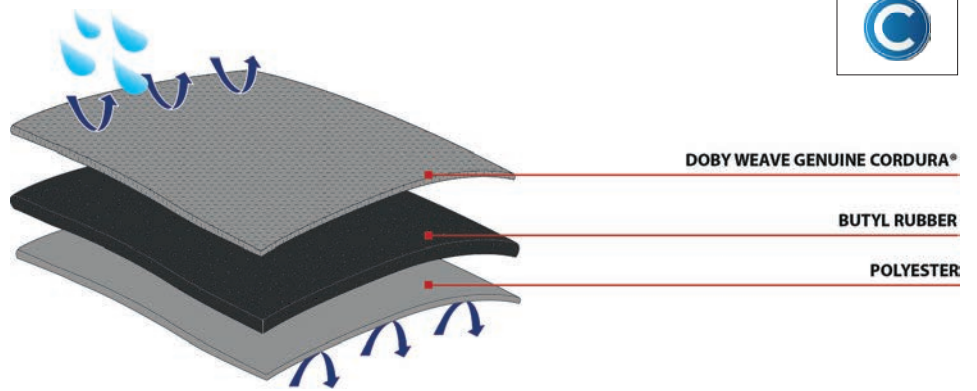

Small Diamond.

F04 Neoprene

Small diamond nylon fabric has a soft hand feel with enhanced heavy 3D textural appearance. Its abrasion resistance is higher than standard nylon fabrics making it very suitable for drysuits.

FABRIC-F04-NEO

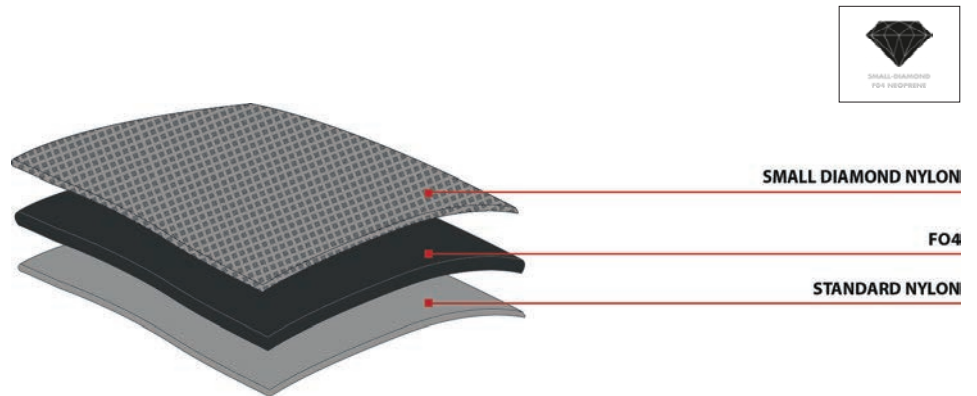

The thickness of the FO4 neoprene varies dependent on suit specifications.
Standard nylon lining : Has a stretchable soft/ smooth texture

KN203 & KN601.

Kevlar®

Kevlar® : light weight, good abrasion-resistance, durability and high in performance.

Versatile and strong Kevlar® fibre is more than just a series of threads.

DuPont™ Kevlar® fibres are used in a variety of Northern Diver apparel to help make them safer, stronger and more durable.

A silky soft man made fibre - 5x stronger than steel, combining great strength with lightweight flexibility.

For use in high wear areas.

Kevlar® **KN203** without an anti slip coating for improved flexibility.

Kevlar® **KN601** is treated with an anti slip coating for improved grip.

DuPont™ and KEVLAR® are trademarks or registered trademarks of E.I. du Pont de Nemours and Company

FABRIC-KN203 or FABRIC-KN601

KN203

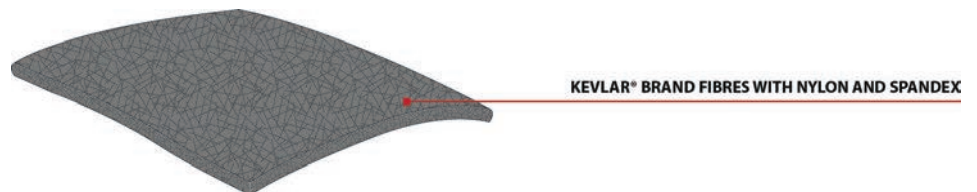

KN601

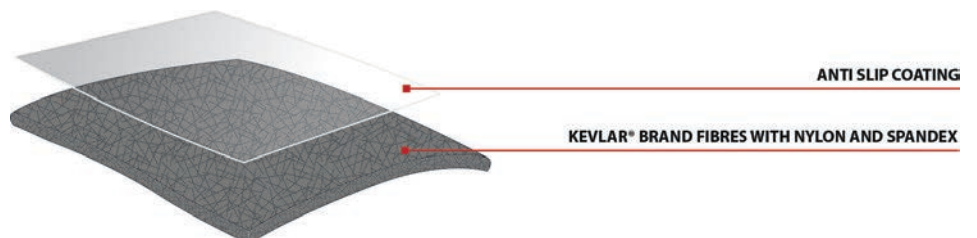

Design. Develop. Deliver.



Product Development.

Working Together to Improve

Northern Diver has staff stationed in the UK, Hong Kong, China and mainland Europe. The product design and development process begins with meetings, either at our headquarters or factories, or via the internet.

The client's requirements are established before work is started. We will then source the best quality materials, or develop our own, and work to create the product through continuous design, sample production and evaluation. All products are tested until the team is happy with the standard. Once we are satisfied, volume production commences.

We look to improve all products. Drysuits, for example, are continuously scrutinised to ensure aspects such as seam placement and cutting patterns are of the highest quality.

Your Specification, Our Expertise . . .

Brief :

Design low profile automatic & variable exhaust/inflation valves with a magnetic signature of less than 5 nanotesla

Result :

Northern Diver delivered a unique design for ultra low profile valves, with an average magnetic signature of just 2.5 nanotesla.

Feedback :

Exceptional, superb quality, unrelenting performance & dependability.

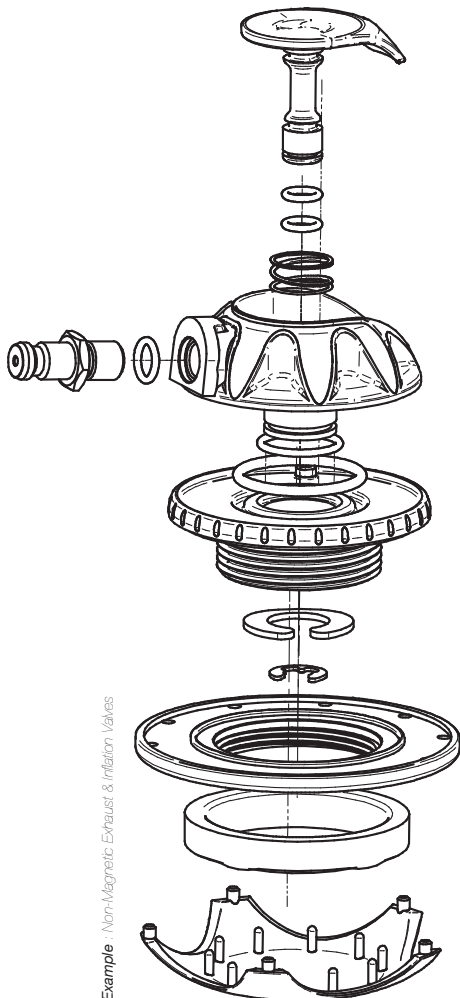

Example - Non-Magnetic Exhaust & Inflation Valves

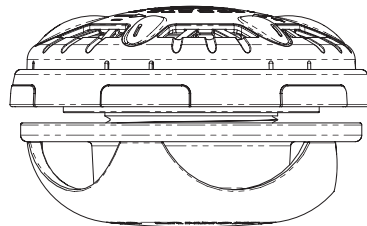
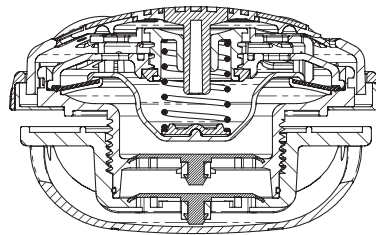

To use the non magnetic symbol for our diving suits and equipment we have our products individually tested at QinetiQ, Portland.

Constant Evolution. Continuous Review. Consistent Quality.



Custom. Tailoring & Repairs

Custom options are available for those buying a stock size drysuit that want to add different elements to what we provide on each standard suit. We can change neck, wrists, socks, and boots to suit your requirements or add pockets, reflective panels and Kevlar® reinforcement in high wear areas. Our full list of custom tailored options are listed in this section.

Custom tailoring options are dependant on the stock suit you purchase. Check the availability of tailoring options on specific suits with us.

We will happily repair drysuits of any brand, but priority will be given to Northern Diver customers. Repairs services can be found on page 00.

Need an instant repair?

A fast track service is available. Contact us on the telephone number below for more information.

Waiting time can vary dependent on our workload. Turnaround can sometimes be as fast as one day, you must call to check on current time frames.

Repairs Department : +44 (0) 1257 25 69 37

Opening Times : Mon - Fri 8.30am to 5.00pm



We want you to purchase the perfect drysuit!

If a stick drysuit is not for you why not design your own? Using our Made-To-Measure system you could have a drysuit meant only for you, perfect for your personal requirements. You can add numerous elements on your drysuit. Choose material, pockets, boots, zipper and seals that fit your unique specification. To complete your drysuit, personalise it with your company logo.

If you cannot find what you are looking for, we always enjoy a challenge. Contact us to discuss how we can help you.

Photographed left : Louise, one of our team leaders in action. Cutting custom fit repairs & alterations. Over 25 years experience.

Custom. Tailoring Options



Options available depend on the stock suit purchased.

The following images are examples of the options that can be provided for custom tailoring stock suits. Available options may vary dependant on the type of stock suit you buy. Tri-laminate and neoprene suits may not allow for all options shown to be applied, please use this as a guide only and call a Northern Diver Sales Representative for specific details.



Non magnetic items are available upon request
To discuss further please call +44 (0) 1257 25 44 44



Please visit the website to view items in more detail
www.ndiver-commercial.com



Neoprene neck
standard inverted & short styles available



Latex neck - standard



Latex neck with neoprene warmer



Hood attached to the suit



Neoprene wrist - standard



Latex wrist - standard



Latex wrist with neoprene warmer



Glued cuff ring system can be used with
latex seals or Ansell Extra™ gloves



Dry glove ring system



Locking cuff dumps



Reflective panels -
any size panel can be fitted anywhere



Kevlar® protection can be fitted to high wear
areas eg elbows, seat, shoulders, knees,
crotch and inside leg



Fly zips fitted with either full or
semi protective zip covers



Pocket extra : stainless steel D-rings
can be fitted to pockets or the suit



Pocket extra : knife loops

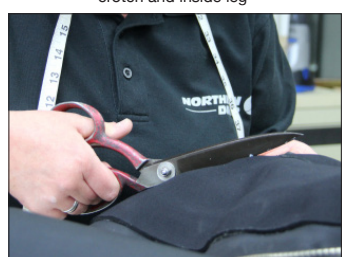

Shorten arms and legs



Adjustable elasticated internal braces



Dogs bone - internal crotch reinforcement



Neoprene suits tapered to fit

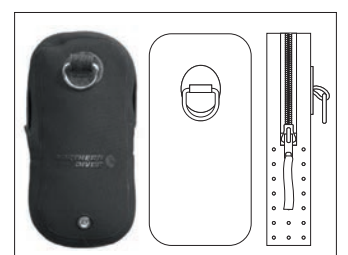

Neoprene zipped transporter pocket with
stainless steel d-ring. 290 x 130 x 40mm



Neoprene bellows pocket with Velcro close flap. 220 x 170 x 40mm



Neoprene transporter pocket & integrated knife pocket. 220 x 140 x 50mm



Neoprene knife pocket with Velcro close flap. 280 x 150mm



Neoprene zipped transporter pocket with 16'' opening. 260 x 160 x 60mm

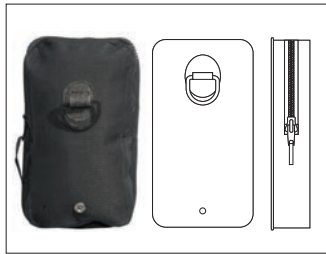

Tri-laminate zipped transporter pocket with plastic d-ring. 290 x 160 x 40mm



Tri-laminate bellows pocket with knife loops. 280 x 150mm



Tri-laminate knife pocket with Velcro close flap. 250 x 180 x 60mm



Fully breathable socks



Latex socks - standard



Latex socks with neoprene warmers



Neoprene socks - standard



Tri-laminate socks
Non breathable, very hard wearing



Breathable socks with Kevlar® protection



Safety boots. EN 12568/98



Durable hard sole boots - dacor



Dacor wide fit boots



Standard slim fit boots



Durable hard sole boots - dive 10

All Northern Diver drysuit boots are handmade, individually vulcanised & fully tested prior to fitting to your drysuit.

Our boots are available in a full range of sizes from UK4-13. Boots beyond size 13 can be custom built.

Please note styles may vary from photos shown dependant on what we have in stock.

With over 25 years experience, our repairs and alterations department has your drysuit in safe hands.

Natalija Matusevica
- Repairs and alterations technician

Repairs. Options

When suits come in for repair they are inspected, tested, worked upon and tested again before they return to the customer. Should your suit show any additional damage, other than stated, Northern Diver will contact the customer to discuss options and additional fees.

Services available :

- Pressure test
- Suit cleaning
- Fixing leaks/minor cosmetic repairs
- Internal re-tape or polymer
- Blank off valves
- Reposition valves
- Reseat and replace valves
- Test and lubricate valves
- Refit zips (YKK and BDM)
- Lubricate zips
- Fit zip flaps (front/rear and flyzip)

We will fix any brand of suit but priority will be given to Northern Diver customers.

A fast track service is available. Contact us on the telephone number below for more information. Waiting time can vary dependent on our workload. Turnaround can sometimes be as fast as one day, you must call to check on current time frames.

Repairs Dept : +44 (0) 1257 25 69 37
Mon - Fri 8.30am to 5.00pm



You can download the current Northern Diver retail price list at www.ndiver.com/pages/Downloads

Trade pricelists are available. If your a trade customer pleas contact us direct on +44 (0) 1257 25 44 44

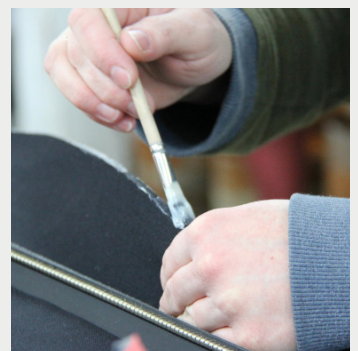
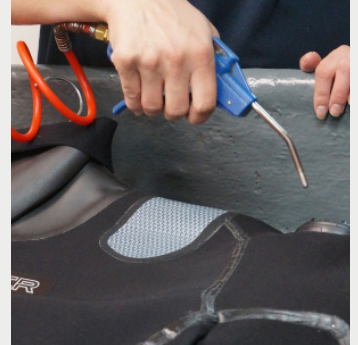

Drysuit Components.

Additions & Accessories To Your Drysuit

Northern Diver has a range of products to help with your drysuit maintenance needs. Should you require an item that is not listed, please contact us.



COMMERCIAL VALVE

Double mushroom valve contains an extra diaphragm than a standard valve.

VALVE-ND-EXHAUST-COMM



EXHAUST VALVE

Fully adjustable 'auto dump' exhaust valves, with an additional 'manual' override facility.

VALVE-ND-EXHAUST



INFLATION VALVE

Available with the standard 'Hanson Seaquest', commercial 'CJEN' or specialist 'SP' style hose couplings.

VALVE-ND-INFLATOR



CJEN HOSE

Includes a 40 inch (1m) inflation hose. Suitable for use with any NDiver drysuit, will also fit most other brands of drysuit.

NDA-NEW-CJEN HOSE



40" STANDARD HOSE

Hanson XL - 40 inch (1m) inflation hose. Suitable for use with any NDiver drysuit, will also fit most other brands of drysuit.

NDA-NEW NDA 40" HOSE



33" STANDARD HOSE

Hanson - 33 inch (84cm) inflation hose. Suitable for use with any NDiver drysuit, will also fit most other brands of drysuit.

NDA-NEW NDA HOSE STANDARD



V-TECH HOSE

Text for this one

CODE FOR THIS ONE



LOCKING CUFF DUMP

Simple and swift opening/closing operation. It turns 45° from open to closed. Mushroom silicone seal stops water ingress when open.

CODE N/A



HOSE PROTECTORS

Made from a very durable material with a high wear factor. Used to reinforce all types of hose and extend the life span of your equipment.

HOSE PROTECTOR BLACK (or) AC-11-2 (or) AC-11-4-BK



INTERNAL BRACES

Come in handy post-dive, if you wish to roll down the top half of your dry diving suit, without removing your suit completely.

BRACES



DRYSUIT HANGER

Drysuit boots are placed in the hanger head and the suit is then suspended upside down, allowing all the excess water to drain away.

HANGER-DRYSUIT



MULTI PURPOSE HANGER

This type of hanger allows the upright drying of a wetsuit, drysuit, BCD or stab jacket, allowing all the excess water to drain away.

HANGER-WETSUIT



SUIT SEAL

Used for repairs to holes and tears in drysuits and for use when sealing the N-Diver dryglove system to neoprene cuffs - tube size : 21grams.

SUIT SEAL REPAIR SET



SEAL LUBRICANT

A water based seal lubricant, will extend the life of your drysuit's neoprene seals and ease getting in and out of your drysuit - 200ml tube.

SEAL-LUBRICANT



SILICONE SPRAY

A water repellent, protectant and lubricant for rubber, plastic and metal parts. Protects against rust, salt-oxidation and corrosion.

SILICONE-SPRAY



TALC

Consists of pure (unscented) talcum powder, supplied in a handy 100g container, with a twist-lock dispenser. To lubricate latex neck and/or wrist seals.

SEAL SAVER



ZIP WAX

Easy, effective drysuit zip lubrication. Simply apply to dry clean drysuit zips to ensure smooth action & prolonged zip life.

ZIP LUBE



LATEX NECK SEAL

Heavy duty latex neck can easily be fitted for you by a member of our professional repairs team, in our on-site drysuit repair facility.

SEAL-N-(SIZE)



LATEX WRIST SEALS

Available in styles 'conical' and 'bottleneck' these seals can easily be fitted for you by a member of our professional repairs team.

SEAL-W-B-(SIZE)



DACOR BOOT

These durable hard sole boots have a generous fit in both the foot and calf. Wide fit Dacor boots can be supplied. Boots available in UK 4-13

DACOR BOOT - 'SIZE'



DIVE 10 BOOT

These durable hard sole boots have a similar design to the Dacor boot, with a closer fit around the foot and calf. Available in UK 4-13

BOOT - DIVE - 'SIZE'



SAFETY BOOTS

A reinforced version of the Dacor boot that features a steel toe and mid sole foil. Available in UK 4-13. Any size above a UK 13 can be custom built.

SAFETY BOOT 'SIZE'



LATEX SOCKS

Keep your feet dry and extremely comfortable with Northern Divers latex socks. Available in sizes S, M, L, XL

SOCKS-LATEX-(SIZE)



HOTWATER SERVICE KIT

A kit for the Hotwater manifold which should be serviced every 3-6 months, or yearly if used less than once a year.

HWS-SERVICE KIT



CUFF RING SYSTEM

The Cuff Ring System has excellent resistance to acids, alkalis, abrasion, chemicals, cutting oils, petrol and gasoline. Excellent option for those interested in replacing seals quickly and easily. Attached directly to the drysuit. Permanent wrist rings mate with Dry Glove Ring System or Latex Wrist Seals (available to buy separately). Used extensively by commercial hazmat, professional, and recreational divers.

CUFF RING + CUFFRING - LATEX + CUFFRING - ORING



BIO SEALS

The Cosmogel that the seals are made from is super soft and stretchy. They are very comfortable and mould to your skin brilliantly. On top of this, durability isn't compromised. The seals simply slide over your neck and wrists, and form an effective bond with your drysuit seal, whether you use neoprene or latex seals.

www.ndiver.com/products/Apollo-BIO-Neck-Seal (or) www.ndiver.com/products/Apollo-BIO-Wrist-Seal

SEAL-NECK-BIO-BLACK-(SIZE) or SEAL-WRIST-BIO-BLACK



Thermal Layers.

Metalux® Undersuit

Metalux® is one of the most lightweight, high-performance insulating materials available.

It is designed to reflect thermal radiation and reduce air movement, even when wet or compressed.

It retains its thermal integrity throughout the life of the garment, which is hard-wearing and machine washable.

Features.

- Lightweight
- Fleece-lined
- Quick-drying design
- Bacteria and fungus resistant
- Pockets on hips
- Elastic foot stirrups

Metalux Temperate.

100 gsm

This model is most commonly used for UK summer diving conditions and/or with drysuits that have thermal properties.

Metalux Arctic.

200 / 300 gsm

This thicker variant is suited to more extreme diving conditions and/or drysuits without thermal properties.

METALUX- ARCTIC or METALUX 330g ARCTIC

S, M, ML, MLR, MR, MLT, L, LR, LT, XL, XLR, XLT, XXL, XXLR, XXXL, XXXL

METALUX - TEMP - SIZE

S, M, ML, MLR, MR, MLT, L, LR, LT, XL, XLR, XLT, XXL



*Styles may vary dependent on size required



Non-magnetic moulded rubber zip pullers



METALUX
ARCTIC

METALUX
TEMPERATE



Chest pocket



Hip pockets



Lower arm stretch panels



Ankle / foot stretch panels



Inner fleece fabric

All undersuits can be supplied without logos.

The Metalux® undersuit's layers are shown left. Working from the top down:

1. 3mm X-otherm fleece/fleece pile lining - sits next to skin.
2. Metalux® - multi-facet film strips, which reflect heat back to body and shield from the cold
3. Soft hollow fibre - acts as an insulator
4. Nylon shell with Teflon® coated outer

Warmth & Comfort.

Thermalux®

A high tech fleece/Lycra® mix for superb insulation and flexibility. Thermalux® undersuits offer a lightweight solution to keeping warm.

The microfibre and fleece layers retain body heat, without excessive bulk.

Flexible panels in the lower back, shoulders, cuffs and feet give exceptional freedom of movement, without sacrificing warmth.

Ergonomically designed foot stirrups ensure the garment stays in position during use, keeping material movement to a minimum and avoiding uncomfortable creasing between the outer garment and your skin.

Suit Features.

- Breathable microfibre outer shell
- Super absorbent micro fleece inner lining
- Ultra lightweight and quick-drying
- Bacteria and fungus resistant
- Elasticated Lycra® panels
- Thermalskin cuffs
- Thermalskin foot stirrups
- Pockets on the hips
- Two way zip

Northern Diver specialises in layer system undergarments for all conditions.

We recommend a Bodyline and Thermalux undersuit for diving in average UK weather conditions.



Elastic thumb loops and stretch panels on the cuffs



Under arm stretch panels

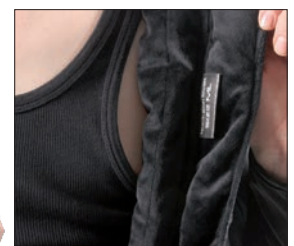

Inner fleece fabric



Hip pockets



Non-mag rubber zip pullers
Ankle/foot stretch panels

All undersuits can be supplied without logos.

THERMALUX - SIZE

XS, S, M, ML, MLR, L, LR, XL, XLR, XXL, XXLR

Commercial.

Thermal Sat Hotwater Undersuit

Manufactured with a heavy duty zip, to withstand washing on the rig and reinforced stitching to increase its working life.

Designed to last up to three times longer than the average undersuit.

The Thermal Sat Suit has minimal seams & no quilting to allow freer movement of gas or hot water around the suit and in action the undersuit avoids cold spots too. Side leg splits with Velcro fastening allow easy access and to ease wearing work boots for deck work.

The suits layered construction helps it to retain heat, even when wet and dries fast to help keep the wearer warm during and after the dive. The suit also drops water fast so worn in the bell post dive; it is warmer and more comfortable than fleece or thinsulate.

Supplied with a storage bag that compresses to be easily stowed away tightly.

Features.

- Hydrophobic layer helps repel water, retain heat and dry quickly
- Chest pocket with removable ID badge and 2x hip pockets
- 2 way YKK Aquaseal zipper
- Integrated, elasticated thumb holes
- Velcro closing side leg splits
- Toughened panels to protect high wear areas
- Highly compressible to allow the suit to be stowed away tightly
- Supplied with a storage bag

This suit is in development, Northern Diver reserve the right to change the design and specification at any time.

Coming Soon

COMMERCIAL

THERMAL SAT
HOTWATER UNDERSUIT



Three Piece System.

Thermicore

This undersuit is available to buy in 2 thicknesses. The **Thermicore** and the thicker version the **Thermicore Sub Zero**.

Each 3-piece system is comprised of a top, bottoms and socks. Each garment fits closely to the body to maximise its thermal performance and ensure that you remain comfortable when diving.

Thermicore and Thermicore Sub Zero features:

- Durable outer shell
- 1 layer super-soft fleece interior lining
- Seams are flatlock stitched
- Super-soft fleece comfort collar
- Integrated foot stirrups
- Elasticated adjustable waistband
- Elastic thumb stirrups
- Red or silver stitch detailed finish (Red stitch available whilst stocks last)
- Abrasion resistant overprinting (Available on selected styles and sizes)
- Low profile sock seams
- Supplied with drawstring carry bag

It's well-known that when diving, some feel the cold much more than others. Depending on the depth that you go to and the time of year in which you are diving, temperature also fluctuates. With this in mind, we have developed the Thermicore Sub Zero, a thicker version of the Thermicore.

Thermicore Sub Zero additional features:

- Additional zipped arm pocket
- An additional super-soft fleece interior lining, making the undersuit thicker and perfect for more extreme conditions

****Please note various styles of these undersuits are available. Contact us for up to date stock information.***

THERMICO^{RE}

THERMICO^{RE}
SUB ZERO



*For protection to the core,
dive Thermicore.*



Zipped pocket (Thermicore Sub-Zero only)

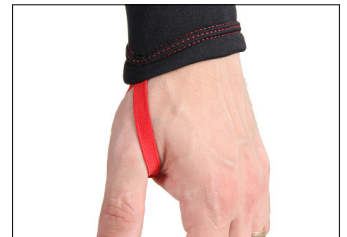

Elasticated thumb stirrups (colour may vary)



Integrated foot stirrups (colour may vary)



Super-soft fleece interior (colour may vary)



Long sleeve thermal top

Thermal bottoms

Thermal socks

Drawstring bag

RED VERSION 1
THERMICO^{RE}-‘SIZE’
or THERMICO^{RE} SUB-ZERO-‘SIZE’

S, M, ML, L, LR, LT, XL, XXL, XXXL

VERSION 2
THERMICO^{RE}-V2-‘SIZE’
or THERMICO^{RE}-V2-SUB-ZERO-‘SIZE’

S, M, ML, L, LR, LT, XL, XXL, XXXL



Thermal Skin.

Bodyline Undersuit

Can be worn as a first layer in conjunction with the Northern Diver range of Metalux® undersuits for more extreme environments.

The Bodyline has proved itself to be an incredibly versatile product. It is not only used by the diving community, but also in many other walks of life where keeping warm is essential.

Many divers are now using their Bodyline as an additional layer of insulation beneath their wetsuit. This is proving to be very successful with those who want to wear their semi-dry wetsuits for longer durations, deeper dives or in cooler waters.

Cavers have also adopted the Northern Diver Bodyline for use beneath caving suits for comfort and warmth on long trips underground.

Even members of some mountain rescue teams wear this undersuit for cold nights on the hills.

MOD - BODYLINE - U/SUIT - SIZE

S, M, ML, L, XL, XXL



Suit Features.

- Close fitting - fits like a “second skin”
- Manufactured from moisture wicking fleece and super stretch Lycra®
- Ideal base layer for surface use
- Breathable fabric
- All black colour

Socks.

Bodyline

Double-sided flatlock stitched, which means that there are no raised seams to cause you discomfort.

They also have a special heel protector and are cut to fit perfectly.

Worn in conjunction with the Bodyline or Anti-Sting undersuit for thermal protection.



MOD - BODY - SOCK - SIZE

UK - S: 5-6, M: 7-8, L: 9-10, XL: 11-13

EU - S: 38-39, M: 41-42, L: 43-44, XL: 45-46

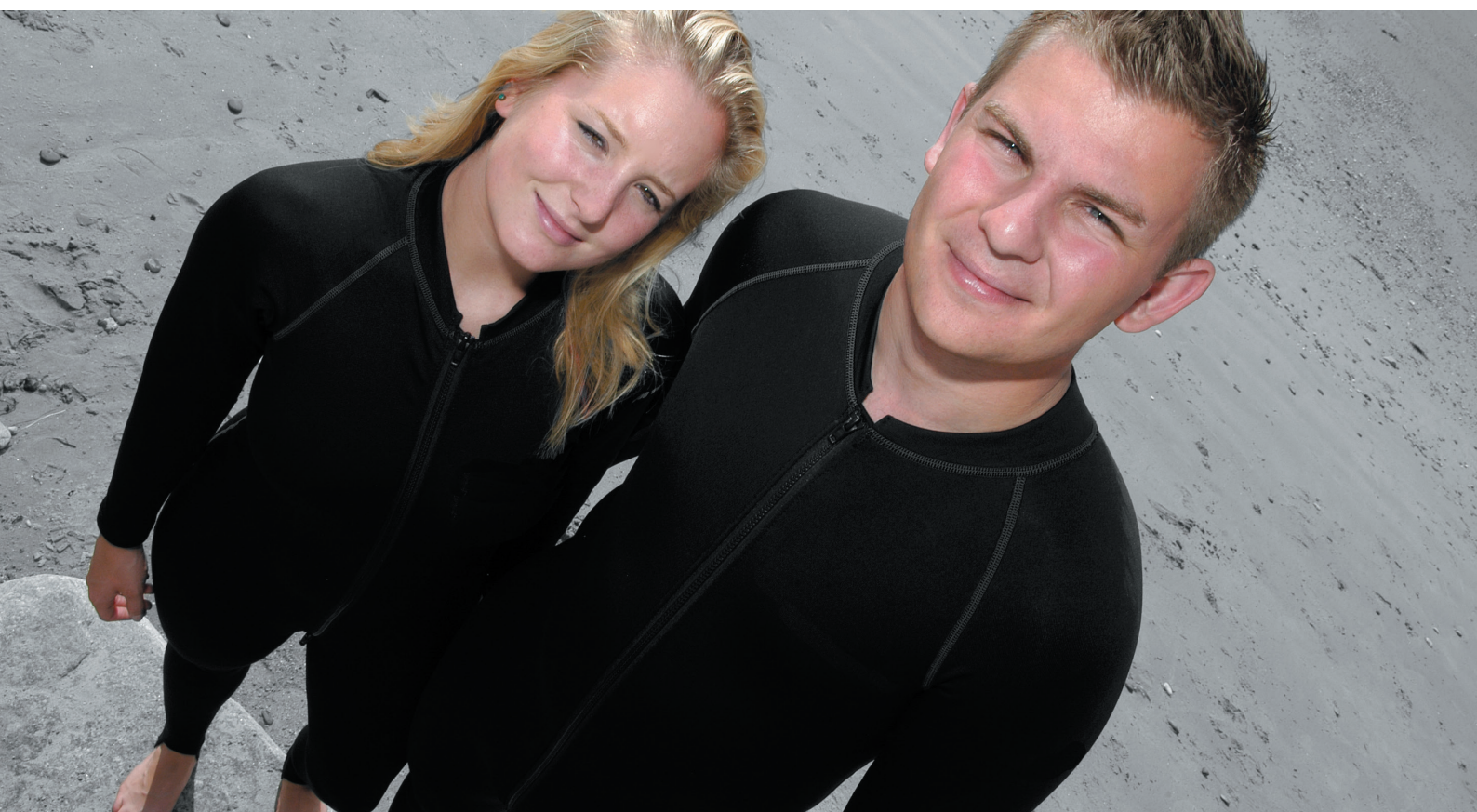

Thermal Base Layer. Rash Vests

The first layer of luxury.

The Northern Diver Rash Vest increases comfort between you and your undersuit or wetsuit, wicking moisture away from your skin, increasing comfort and reducing the chill factor.

This base layer, next to your skin, is one of the most important layers in managing heat loss.

Rash Vests allow your undersuit or wetsuit to glide with your body movements, making it helpful when getting in and out of these garments. Photo right shows long sleeved rash vest.



RASH VEST - SIZE



Rash Vest Features.

- Available in long and short sleeves
- Colours vary dependent on stock
- Can reduce salt water irritation
- Slip in and out of suits easier
- Wicks sweat away from your body
- Suitable for most water activities

Hood Attached. Neoprene Vest

A 3mm super-stretch neoprene vest. Suitable for use in tropical waters, or underneath a wetsuit in cold conditions. Features triple glued and blind-stitched seams.



MOD - 2MM - VEST



Thermal Footwear. Hot Sox

These are made from moisture-wicking fleece, keeping your feet warm and comfortable.

The socks are double sided and flatlock stitched - no raised seams to cause discomfort.

They have a special heel protector and are cut to fit perfectly.

Moisture is always present inside any diving drysuit, often produced by the diver's body. Hot Sox wick this moisture away from the skin to keep you comfortable.



WICKING FLEECE

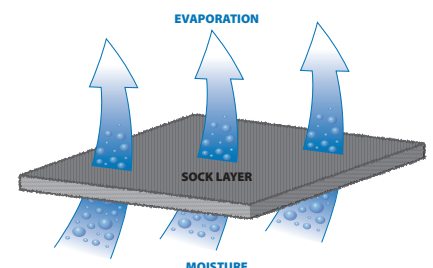

HOTSOX - SIZE

XS S M L XL

Available in sizes:

XS: 3-4 (36-37) **S:** 5-6 (38-39) **M:** 7-8 (41-42) **L:** 9-10 (43-44) **XL:** 11-13 (45-46)

4-WAY
SUPERSTRETCH
NEOPRENE



YKK
Little Parts. Big Difference.

Military 2 Piece Wetsuits.

Tropical & Temperate

This wetsuit system is supplied to the MoD for use across the forces. The system comprises of the Tropical wetsuit and the Temperate wetsuit. Both are two piece, comprising of a shortie over jacket and long john wetsuit.

The system is designed to offer the user an all-round solution for diving in different temperatures. Users can choose to wear one garment from either system if they wish. Additionally, garments from both systems can be worn together.

Normally used with a rash vest and neoprene socks.

Wetsuits conform to non-magnetic requirements and are labelled accordingly.



YKK zip with Velcro closing tab



Extra protection on elbow area



Extra protection on knee area



Above:
Long John Wetsuit
Available in 5mm Tropical
& 5mm Temperate

Above:
Shortie Over Jacket
Available in 3mm Tropical
& 5mm Temperate

Shortie Over Jacket

Available in 3mm Tropical & 5mm Temperate

- Super-stretch neoprene garment
- Short arms and legs
- YKK non-magnetic zip
- Suitable for use in tropical and similar conditions above 18°C
- Non-chafe collar
- Flatlock stitched

MOD - TROP - SHORT - SIZE or MOD - TEMP - SHORT - SIZE

S, M, ML, L, XL, XXL

Long John Wetsuit

Available in 5mm Tropical & 5mm Temperate

- Super-stretch neoprene garment
- Long arms and legs
- Knee and elbow pads for protection
- YKK non-magnetic zip
- Suitable for use in tropical and similar conditions
- Smooth skin floating collar
- Glued and blind stitched

MOD - TROP - LONG - SIZE or MOD - TEMP - SLEEVED - SIZE

S, M, ML, L, XL, XXL

4-WAY
SUPERSTRETCH
NEOPRENE



YKK
Little Paris. Big Difference.

2 Piece Commercial Wetsuit.

Delta Flex Black

The hard-wearing properties do not detract from the ultimate comfort offered by the super-stretch DFN-Ultragrade™ neoprene.

The internal lining offers superb warmth and insulation with its Ti-Ax® Thermacote® Titanium Terry lining, now with anti-bacterial coating.

The build quality is exactly what divers have come to expect from Northern Diver wetsuits offering tough water-tight seams, high quality materials and components and exceptional quality control.

The DeltaFlex Black will fit everyone, no matter what their size.

The ergonomic cut of the suit plus the preformed and shaped arms and legs offer maximum in-water comfort.

Features

Unique Ti-Ax® Thermacote® Titanium lining for warmth and comfort

5mm neoprene jacket, nylon outer and plush Ti-Ax® Titanium Terry lining

All seams : triple - glued and blind stitched

Step-through crotch jacket

Single lined smooth - skin neoprene face & wrist seals with zips

Front entry with full length zip and short sleeves

Single lined smooth - skin neoprene ankles / arm seals on the Long - John



Black neoprene hood



Velcro closing collar



Reinforced seams

This is the most popular wetsuit for the commercial and oil industries.

It is also supplied to the Military world wide.



Neoprene cuff seals with zipped protective over cover



Neoprene ankle seals with zipped protective over cover



Black overprinted knees for extra abrasion resistance



Full length, front entry, YKK Aquaseal zips used on the long john and beaver tail



Beaver Tail 2 Piece.

Army / Engineers

2 piece wetsuit with integrated hood.

Consists of 'farmer john, long john and beaver tail' overjacket.

Kevlar® kneepads.

Double layered cuffs with inner seal and zip fastening.

Available in 5 - 7mm.

Ti-Ax® Thermacote® Titanium lining.

Ideal for temperate conditions.

WETSUIT - BELGIUM

S, M, L, XL, XXL



YKK
Little Parts. Big Difference.

4-WAY
SUPERSTRETCH
NEOPRENE



www.ndiver-commercial.com



2 Piece Wetsuit.

Search & Rescue

Consists of steamer and shortie wetsuits, which both have a Kevlar® coated seat area and chest zip. These garments can be worn separately.

Manufactured from a high visibility red 4mm neoprene. Frequently used for helicopter search & rescue operations/training.

Includes separate wet hood. Features torch pockets that house lighting equipment used by SAR and military divers.

MOD-SAR

S, SW, M, MW, MEW, L, LW, XL, XLS, XXL, XXLS, XXLES

(W = WIDE, E = EXTRA, S = SHORT)



Neoprene hood with reflective print and torch mount on the right side.



YKK
Little Parts. Big Difference.

4-WAY
SUPERSTRETCH
NEOPRENE



Pockets on both arms



YKK plastic zip with Velcro closing tab



Panels added for extra stretch

CE Approved.

Dry Glove System

Loss of movement or manual dexterity, due to cold hands, can be dangerous during a dive, as well as being uncomfortable for the diver. Maintaining hand warmth and a divers ability to efficiently operate their essential diving equipment, is vital to safe diving and maintaining a high level of dive comfort. Northern Diver are proud to manufacture and continue to innovate our revolutionary concept in dry diving glove systems.

This unique system is trusted by technical divers on deep dives, recreational divers in cold water environments, commercial divers in more extreme diving environments and Environment Agency divers all over the world, in an incredibly diverse range of diving conditions and even in contaminated water environments.

Fitting this dry glove system to your own drysuit is easy, as the package includes the unique bespoke fitting tool, sealing adhesive and a sealing adhesive application brush, all combined in one 'complete' dry glove system package.

[Ansell Extra™ glove]

- Extremely high resistance to many ketones, salts, detergents, alcohols, alkalis and fats
- 100% cotton flocklining provides a softer more comfortable glove that helps absorb perspiration
- 100% natural rubber with no filters
- Excellent resistance to mechanical hazards plus increased chemical protection
- Chlorinated for better grip and increased chemical resistance
- Heavy duty handling where sensitivity is also required

[Thermal fleece inner glove]

- Thermal 4-way stretch fleece
- Flatlock stitched seams for comfort
- Snug fit around wrist area for additional thermal protection
- Removable for warmer waters or for use post dive

[Package includes]

- Ansell Extra™ gloves
- Thermal fleece inner gloves
- 2 dry glove modules
- 3 sealing rings
- Locking tool
- Adhesive sealant
- Instructional video available online



Gloves conform to the requirements of European Directive 89/686/EEC and to the European standards EN420:2003 + A1:2009 and EN374:2003, EN388:2003

Our unique dryglove ring system has been designed for use in conjunction with neoprene or membrane drysuits, using latex or neoprene wrist seals.

Once fitted to a divers suit, the unique twin-safe locking ring mechanism, allows quick and easy glove engagement and the equally quick release of the drygloves, without the need for assistance.

For your convenience, we have also created an instructional video, available to view (anytime) on Northern Divers dedicated You Tube channel



Ansell Extra™ gloves

Inner fleece gloves

Dry glove rings



Suitseal

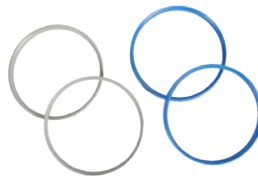

Sealing rings



Locking tool

Northern Diver's Dry Glove System is suitable for both arctic conditions & contaminated water environments.



GLDRY - SYSTEM - V3 - SIZE

S, M, L, XL

Accessories. Gloves



Helmet photographed supplied by Kirby Morgan Dive Systems, Inc.



SUPERSTRETCH SUPER COMFORTABLE & WARM



These gloves are manufactured from our unique 4-way super-stretch neoprene. They are reported to be the easiest of all our gloves to put on and take off.

These gloves are available in 2mm, 5mm and 7mm neoprene. For warmer water or surface use, we recommend the 2mm option. Our 5mm and 7mm options are ideal for cooler conditions, where thicker gloves are essential.

Even at top thickness, these gloves don't compromise dexterity.

2MM SUPERSTRETCH

GL2-S/S - 07 - SIZE

S, M, L, XL

5MM SUPERSTRETCH

GL5-S/S - 07 - SIZE

XS, S, M, L, XL

7MM SUPERSTRETCH

GL7-S/S - 07 - SIZE

M, L, XL



AMARA PALM/NEOPRENE IN BLACK

Designed specifically for rescue services. Manufactured from 2mm neoprene, with Amara type faux suede on the palm and finger area for grip. Palm area is double reinforced. Ideal for roping use.

The Velcro closure wrist system keeps flushing to a minimum.

GL - SRE - SIZE

S, M, L, XL, XXL



5MM BLACK OPTIMUM GLOVES

Featuring our unique Ti-Ax® Thermacote® heat-reflecting lining. Manufactured from premium polymer, featuring DiamondFlex for superb protection and our Super-Tack embossed palms and fingers to improve control and grip.

A tight-fitting wrist seal to minimise water migration but can make the glove difficult to pull on over your hand.

GL5-OPTIMUM BLACK-'SIZE'

S, M, L, XL, XXL

5mm Neoprene. Hotwater Gloves

Specific integration and use with only the Northern Diver Hotwater suit. Manufactured from 5mm neoprene with Kevlar® reinforced palms and fingers.



GLM-GAUNTLET-KEVLAR-SIZE

M, L, XL, XXL

Hard Wearing. Hot Grabber Gloves

Our Hot Grabber glove is ideal for divers who are looking for a cut resistant, hard wearing glove.

Whilst this glove is designed for use with our Hotwater system for deep commercial diving, it is also an ideal hard wearing glove for non-commercial divers who require a similar level of protection.

The Hot Grabber offers excellent resistance to abrasion and strong resistance to chemicals, acids, alkalis, cutting oils and petrol. The colored over-dip acts as a wear indicator.

In compliance with the standards EN420 (general requirements), EN388 (mechanical hazards) and EN374 (chemical and micro-organisms hazards).

Manufactured under an EC quality assurance system carried out by the BSI body.



Available in two colours



GL-HOT-GRABBER

M, L, XL

7mm Neoprene. Kevlar® Mitts

Ideal for cold water diving, these mitts are manufactured from 7mm superstretch neoprene, which will keep your hands super warm and protected.

The protection of this mitt is additionally enhanced with Kevlar® from the tips of the fingers right down to the palm. The glove also has polymer reinforced seams.



GL7-K-SIZE

S, M, L, XL, XXL



3MM KEVLAR® GLOVES

Extra strength and protection for when it counts.

The ultimate combination of luxurious super-stretch neoprene, Kevlar® palm and fingertips protection, and polymer coated fingertips.



5MM KEVLAR® GLOVES

The ultimate hard-wearing dive glove with glass-reinforced fingers.

Kevlar® gives extra strength and protection to these 5mm gloves, without compromising on dexterity.

Designed for colder diving conditions, the gloves also feature Ti-Ax® Thermacote® lining.



DRYTEK GLOVES

Drytek gloves have a thin double-wall nitrile shell, which is textured for grip. The use of this material makes the gloves hard-wearing, but lightweight and easy to manoeuvre your hands in.

Inside, a seamless 15-gauge soft nylon liner keeps your hands comfortable. These dry gloves also provide chemical resistance against oils and greases.

GL2-K-SIZE

S, M, L, XL

GL-5-K-SIZE

XS, S, M, L, XL, XXL

GL - DRYTEK - SIZE

S, M, L, XL



SEMI-DRY GLOVES

5mm neoprene gloves suitable for a wide range of diving conditions where you want to keep your hands warm and your gloves securely in place for the duration of the dive.

Neotex wrist seals on the gloves form a 'water lock' system. This seal system ensures no flush from the gloves, keeping your hands warm.



THERMAL DRY GLOVES

A simple alternative to our full Dry Glove System.

Polymer gloves with separate thermal fleece liners, featuring a latex seal.

The durable textured synthetic outer is chemical, cut and puncture resistant. An Isotherm fleece lining helps maintain warmth and comfort.



NEOPRENE GLOVES

These neoprene gloves combine comfort, warmth and flexibility.

The palm, fingers and thumb feature a hard-wearing protective coating. Water migration is minimised with the addition of an elasticated Velcro wrist strap.

Available in 3, 4 and 5mm.

GL01 - SIZE

S, M, L, XL, XXL

GL - DRY - HELIOS - SIZE

S, M

GL5-08 - SIZE - THICKNESS

S, M, L, XL

Accessories.

Footwear & Fins



SAFETY ROCK SWIM BOOTS



These all terrain boots are designed to expel water post-dive to increase comfort and retain foot protection out of water.

They are also suitable for traveling to a dive site, as they can be worn with or without additional socks, and fins can be directly fitted over the boots.

The boots give far greater protection than our standard Rock Swim Boots, essential when more substantial PPE is required.

Giving maximum comfort and control, these boots will allow the wearer to perform their tasks on dry land, in water and under water.

Complies with the EC directive for Personal Protective Equipment (Directive 89/686/EEC) and meets the requirements of the European standard EN ISO 20345:2004.

- Composite toe and mid-sole foil
- Rugged hi-grip heavy-duty outer sole – oil and chemical resistant
- Suitable for use in and out of water
- Multi-point Velcro securing straps
- External ankle protection
- Cladding protection on heel, toe and sides

BOOT-COMPOSITE - SIZE

5 - 13



ROCK SWIM BOOTS



Rock Swim Boots are designed to be used with most models of drysuit, with attached latex/neoprene socks or wetsuit socks.

These boots are designed to expel water post-dive, for additional foot protection (after diving) on a boat deck or back on land.

Offers the user excellent grip on boats and ladders. Comfortable to wear for swimming and diving. Ideal for all terrains such as land, sand and rocky terrains.

- Lace up
- Velcro ankle closure
- Fitted internal neoprene socks
- Oil and chemical resistant sole
- External ankle protection
- Cladding protection on heel, toe and sides

MOD-BOOT2-SIZE

6 - 13



THOR SAFETY OVERBOOTS

- Steel toe cap overboots
- Toe cap tested to EN 12568:2010
- Improves diver safety
- Extends the working life of diving suits
- Protects the lower extremities from sharp, abrasive materials and impacts
- Exceptionally resistant to wear

THOR - OVERBOOT
ONE SIZE



BLACK NEOPRENE WETBOOTS

- These wetsuit boots feature a durable YKK side zip, for ease of use, a rugged anti-slip rubber sole and incorporate additional protection around the heel and toe areas.
- Manufactured from 5mm neoprene
- Titanium lined
- Anti-slip rubber sole
- Heavy duty durable YKK side zip
- Heel and toe protection

WETBOOT - ALL - BLACK - SIZE
5 - 13



VIBRAM® SOLE CANYON BOOTS

- Composite toe and mid-sole foil
- Tested to EN ISO 20345 standard
- Super-Grip Vibram® rubber sole – oil and chemical resistant
- Neoprene insoles for extra comfort
- Generous opening with velcro fastening
- External ankle protection & drain holes
- Two positive velcro straps

BOOT-CANYON - SIZE
6 - 13



HOTWATER BOOTS

- High grade 5mm neoprene
- High cut of the boot ensures the hot water is trapped within the suit and the boot
- Keeps the diver warm and comfortable
- Worn in conjunction with the Hotwater suit

BOOT - HOTWATER - SIZE
S, M, L, XL, XXL



TEMPERATE SOCKS

- Comfortable fit
- Double-sided flatlock stitched
- No raised seams to cause discomfort
- Black only
- Neoprene super-stretch

MOD-TEMP-SOCK
ONE SIZE FITS ALL



BODYLINE SOCKS

- Double-sided flatlock stitched - no raised seams to cause discomfort
- Black only
- Special heel protector and snug fit
- Can be worn in conjunction with the Bodyline or Anti Sting undersuits

MOD - BODY - SOCK - SIZE
S: 5-6, M: 7-8, L: 9-10, XL: 11-13

Accessories.

Fins & Fin Straps



CODA DUAL FIN



More power is delivered through these fins, with less effort required from the diver.

The patented design allows water flow to interact with each fin blade, producing independent thrust from each fin. The fins also produce thrust on each up AND down stroke, improving finning efficiency.

The polymer was developed to ensure a stronger fin action in currents. The elastomer has a soft feel, with good spring, and retains its unique shape even in arctic waters.

- Patented dual split-fin design
- Unique 'nature's wing' shape
- Superb power and performance
- Heavy duty build quality
- Very efficient finning on up/down strokes
- Lightweight
- Boot size: M fits 4-6 UK , L fits 7-10 UK, XL fits 11+ UK



FIN - CODA - SIZE



JET FINS (METAL AND PLASTIC BUCKLE OPTIONS)

Our Jet Fins are manufactured from a very high quality rubber, using the latest manufacturing processes.

They are very weighty and robust - specifically designed for maximum endurance, exceptional propulsion and the ultimate finning power.

- Available with two buckle styles
- Tested in extreme commercial diving conditions
- Preferred choice of divers around the world
- Manufactured from high quality rubber
- Robust and superb endurance
- Exceptional finning power
- L, XL, XXL, XXXL



PLASTIC : FIN - JETFIN - QR - 'SIZE'

METAL : FIN - JETFIN - 'SIZE'



SPRING FIN STRAPS (METAL AND PLASTIC)

Robust spring fin straps, designed to make it easier to put on and remove your fins. Manufactured from marine-grade stainless steel for low maintenance. Easily fitted to most brands of diving fins.

- Stainless steel spring
- Flexible rubber outer
- Very comfortable
- Available with a metal or quick release plastic buckle
- Sizes: S=6-8, M=9-11, L=12-14



FIN - SPRING - SIZE

Commercial.

Bio Full Face Mask

The Bio Full Face mask has been designed with superior vision in mind, and it additionally incorporates a high performance regulator for underwater construction and surveys, as well as technical and military diving applications.

Designed to minimise internal volume, and maximise the field of vision. This low volume ergonomically designed mask achieves very low dead space volume, therefore reducing air consumption and CO2 buildup.

N/A



www.ndiver-commercial.com

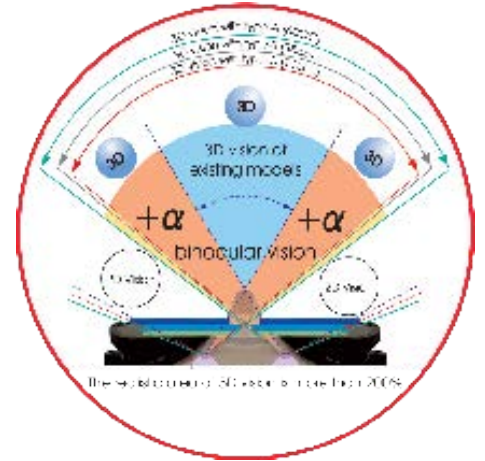

SURFACE BREATHING VALVE (SBV)

The mask is equipped with an SBV on the left hand side. By simply opening the valve, you can easily breathe on the surface, thus reducing overall air consumption (left: closed, right: open).

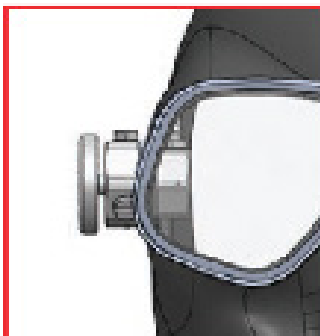

DEFOGGING DEVICE

A lens demisting device is installed next to the right hand lens. With the simple push of a button, air blows across both lenses and instantly removes fog and mist from the lens. The push button method is far easier to control in comparison to rotary valves that can inject air very fast and break the mask's seal.

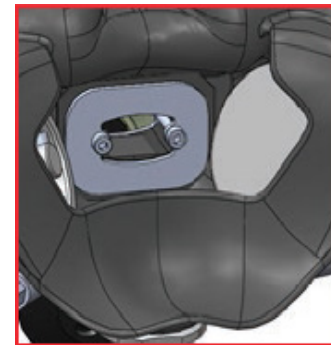

SECURING THE REGULATOR TO THE MASK

The regulator cannot be pulled away from the full-face mask as it is fixed with a robust stainless steel plate. Built to EN140 standard.



MATERIALS USED TO MAKE THE MASK FLANGE

The mask flange is manufactured using NBR (nitrile rubber or buna N), an oil-resistant synthetic rubber. This material has proven resilience against many contaminants and a high tear strength.



SECOND STAGE

Unlike standard 2nd stages this unique design incorporates a fully sealed system between the exhaust valve and retainer that prevents any micro leaks. Furthermore the larger exhaust valve significantly reduces breathing resistance.

The Quick Disconnect Coupling (QDC) air coupling incorporates an automatic safety lock. It is not recommended to operate the QDC while actually in contaminated water.

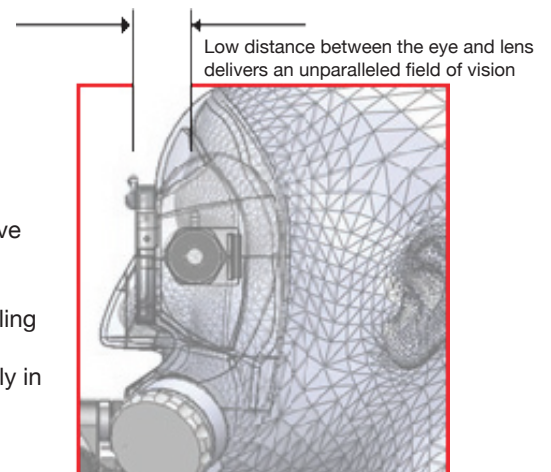

Full Face.

AGA Mask

The DIVATOR valve is one of the most reliable valves available. It performs in even the harshest of conditions, such as mud, oil and fast-flowing cold currents.

Positive buoyancy generated from air inside the mask is reduced by the low-volume visor. Additionally, the low volume of "dead space" inside the mask reduces re-inhalation of CO₂.

The mask is also very easy to drain of water. Simply press the button and hold the lower part of the mask out from the face.

The DIVATOR comes equipped with spectacle retainer inserts. It is also prepared for underwater communication. The airflow design reduces noise turbulence, making communication easy.

Designed for cold-water dives.

Features.

- EN 250 compliant
- Medium pressure range: 5-11 bar
- Opening pressure: 12-20 bar
- Breathing valve LP connection: M16 male (hoses for alternative connections are available)
- Temperature range: -30 to 70°C
- High air flow capacity and low breathing resistance for increased diver performance
- Safety valve
- Leak-preventing double sealing on the exhalation valve and soft, flexible mask sealing
- Low "dead space" volume - air consumption and CO₂ build up is minimised
- Purge button for water drainage



Accessories.

Mask Mounting Rail System

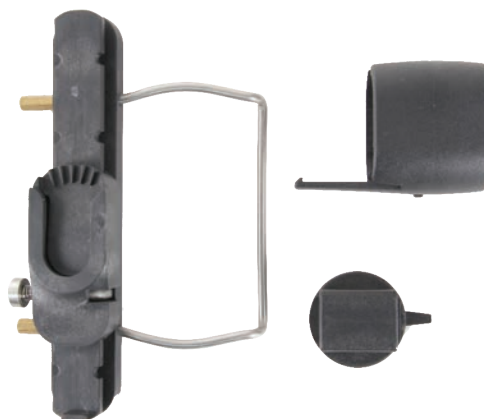

The mask mounting rail system is easy to attach to the full face mask, no tools required. Adjustable up and down the rail and 45° each way to adjust a mounted torch beam.

Quick attachment of various accessories to the rail including dive lights, video camera, welding visor, etc. Attach multiple accessories to the same mask.

Allows the diver to use both hands. "Hands free", for difficult tasks. No interference with ambient air valve.

Deep Sea.

Dive Helmets

The Bandit is a soft shell helmet, product of the mix between the full helmet DSL B-2 and a Band Mask. It keeps the divers head completely dry but without having the weight of a full helmet.

Weight: 7.8 kg
Dimensions:
300mm x 300mm x 300mm
(length x width x height)
Regulator: Scubapro A 700

The soft neoprene hood is covered by a ergonomic glass fibre shell to adjust the volume of the helmet and it protects the divers head against shocks.

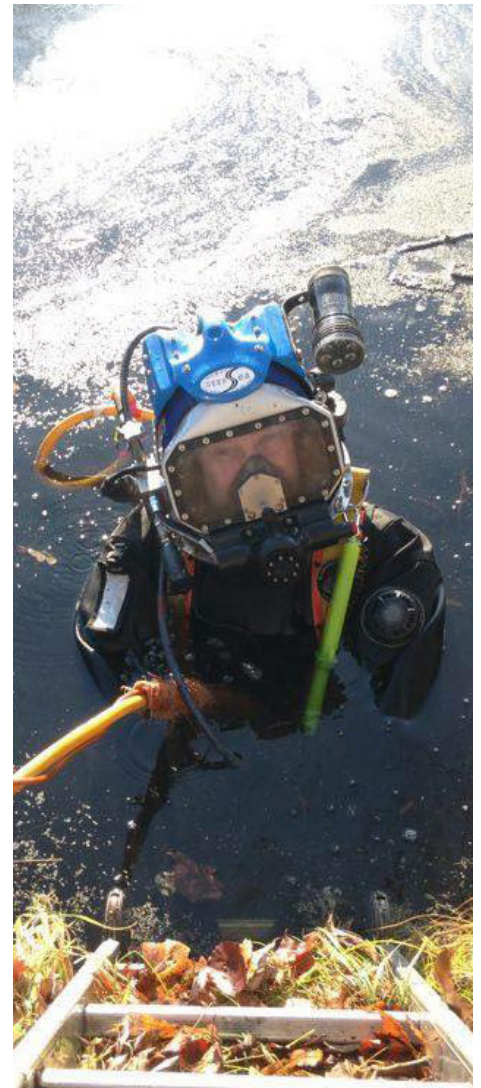

The Caribe Dive Helmet is a surface demand life support system. Equipped with a standard SCUBAPRO A700 demand valve, the demand valve adjustment allows an optimal breathing comfort. It has a neutral buoyancy for an optimized comfort underwater and a quarter-turn valve ensures a rapid bailout opening in case of emergency.

Weight: 12.8 kg
Dimensions:
380mm x 300mm x 340mm
(length x width x height)
Regulator: Scubapro A 700

The Caribe is equipped with double overpressure valves, a separated and silent free flow and defog system, a communication system, an adjustable inner liner, a bronze neck ring with neoprene neck-dam and an anti-panic closing/locking system.



The Nuclear is a dive helmet designed for underwater works in polluted environments. It has a neutral buoyancy for an optimized comfort underwater.

Weight: 13.8 kg
Dimensions:
380mm x 330mm x 340mm
(length x width x height)
Regulator: Scubapro A 700

The Nuclear is mounted with a double spring loaded overpressure valve to ensure the divers security in polluted media. This system ensures a constant overpressure of 5mB inside the helmet and avoids the flow-back of any poisoned particles.



Super Powerful Aluminium Torch.

Varilux 3500

The Varilux 3500's output is an incredible 3500 lumens. This output is supplied by four CREE XM-L2 LEDs. Output is varied with the top-mounted magnetic slide switch.

Just like the other torches in the Varilux family, the Varilux 3500 is manufactured from aircraft grade aluminium and supplied in a useful carry case.

- 200 - 3500 lumens
- 1000m (Beam Distance)
- 90000cd (Peak Beam Intensity)
- 0.5m (Impact Resistant)
- 100 meters underwater/diving
- Anodised aircraft 6061 aluminium
- Colour: Silver/grey
- LED: 4x CREE XM-L2
- LED lifespan: 100000 h
- Brightness: 3500 lm
- Light colour: white
- Mode: High/dimming
- Battery: 26650 3.7 V, 4000 mAh
- Magnetic slide switch
- Coated glass lens
- Size: 217 x 69 x 130 mm
- Weights:
 - Torch: 586 g
 - Torch & batteries: 772 g
 - Torch, batteries & charger): 924 g

TORCH-VL35-UWL

varilux FAMILY



Included with the torch: 26650 battery x 2, 26650 battery charger x 1, Spare o-ring x 1, Tail cap lubricant x 1



4x CREE XM-L2 LEDs



Magnetic sliding switch



Batteries removed from the bottom

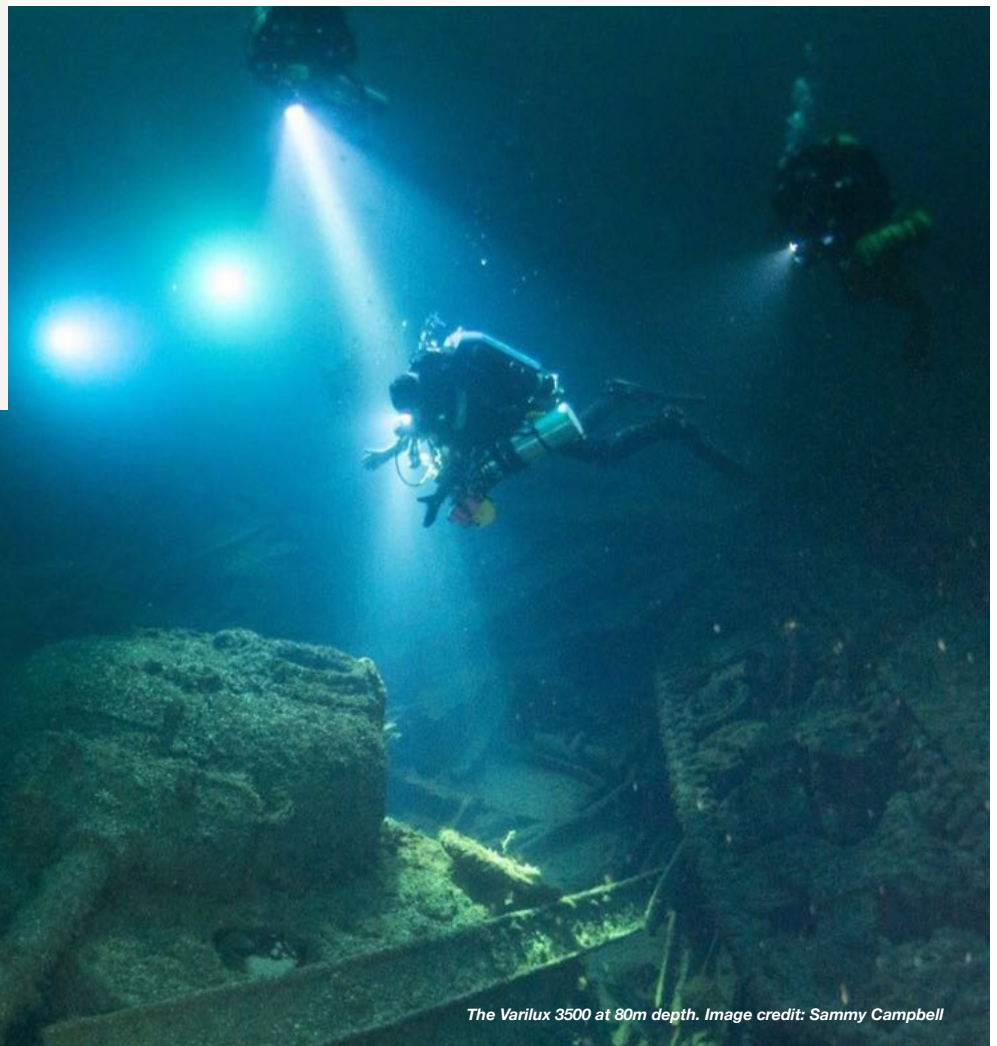

The Varilux 3500 at 80m depth. Image credit: Sammy Campbell

Rechargeable.

Varilux Travel II-R

The Travel II R is supplied with an Xtar MC1 Plus intelligent USB battery charger and an adapter for charging from a car power outlet. Integrated battery indicator lets you know when it needs to be recharged.

- Anodised aircraft grade 6061 aluminium
- Colour: Silver/grey
- LED: 1x CREE XM-L2
- LED life span: 100000 h
- Brightness: 80-1000 lm
- Light colour: White
- Beam distance: 1000 m
- Peak beam intensity: 30000 cd
- Impact resistance: 1 m (dropping height)
- Depth rating: 100 m
- Mode: High/dimming
- Burn time: 2 h (1000 lm), 2-30 h (1000-80 lm), 40 h (80 lm)
- Magnetic induction switch
- Coated glass lens
- Size: 161 x 45 mm (length x head diameter)
- Weight (torch): 232 g
- Weight (torch and battery): 324 g

TORCH-VLTRAVEL2



Tested to 100m.

Included with the torch: USB battery charger, battery charger includes a car adapter, 26650 rechargeable Li-ion battery (3.7V, 4000 mAh), lanyard, spare o-ring and lubricant for opening points



Rechargeable.

Varilux Micro R

- Anodised aircraft grade 6061 aluminium
- Colour: Silver/grey
- LED: 1x CREE XM-L2
- LED life span: 100000 h
- Brightness: 80-800 lm
- Light colour: White
- Beam distance: 500 m
- Peak beam intensity: 20000 cd
- Impact resistance: 1 m (dropping height)
- Depth rating: 100 m
- Mode: High/dimming
- Burn time: 1.5 h (800 lm), 1.5-24 h (800-80 lm), 24 h (80 lm)
- Magnetic slide switch
- Coated glass lens
- Size: 147 x 35 mm (length x head diameter)
- Weight (torch): 153 g
- Weight (torch and battery): 197 g

TORCH-VLMICRO2

The new Varilux Micro is rechargeable and capable of producing 800 lumens for 1.5 hours.

Producing much more power than its small and slim profile might suggest, you may wish to use this torch as either a backup or primary lighting source.



Included with the torch: Xtar MC1 Plus intelligent USB battery charger, 18650 rechargeable Li-ion battery (3.7V, 2200 mAh), lanyard, spare o-ring and lubricant for opening points



Head Torch.

Glare

The Glare Head Torch has been designed for a range of outdoor uses. It has a simple push button operation and features an integrated SOS whistle.

With the integrated red diffuser, you can switch easily from a white spot beam to a red flood beam to adapt to your environment.

- Compact & Lightweight
- Simple Push Button Operation
- Excellent Performance
- CREE-XP-G2 LED Light
- Flick Down Red Diffuser
- 4 Light Modes
- Material - ABS
- Adjustable Non-Slip Head Strap
- Adjustable Torch Head
- Low Battery Warning Light
- Integrated SOS Whistle
- Colours: White or Black
- 3X AA Batteries
- Weight : 0.232 kg
- Packed dimensions : 27 x 10 x 4cm

TORCH-GLARE-COLOUR

GLARE
HEAD TORCH



GLARE HEAD TORCH CAN BE USED WITH ANY OF OUR HELMETS



CREE-XP-G2 LED light



Flick down red diffuser



Adjustable torch head



Non-slip head strap



Integrated SOS whistle



3x AA batteries

Underwater.

Fusion X4

The latest model of our Luxeon underwater torch, with cutting-edge technology and the usual excellent Luxeon build quality.

The X4 has a redesigned LED, light reflector and switch assembly, for the ultimate package of superb performance and durability. It also features Super-Luxeon pure white light technology, for fantastic focused beam and a colour temperature of 5300K.

- Super high 310 lumens output
- Natural daylight colour temp 5300K
- 8.5hr total continuous burn time
- New optically enhanced reflector
- Philips Lumileds T 3w Luxeon LED
- Depth tested to 95 metres
- Tough poly carbonate body with aluminium head
- Double O-ring seals
- External magnetic on/off switch
- 4 x AA alkaline batteries (supplied)
- Weight : 0.462kg
- Packed dimensions : 6 x 6 x 18cm

TORCH-FUSION-X4



Magnetic on/off switch



Aluminium torch head



Protective rubber outer casing

Pure Power. Mini Quest

Northern Diver's powerful Mini Quest long burn underwater LED torch is now even brighter - 230 lumens output.

The Mini Quest underwater torch has an 8.5 hour total (continuous) burn time, using specially developed variable output technology.

(100% full power output for 3.5hrs, which then gradually decreases over the remaining 5hrs burn time).

LED 36Hrs Burn Time. Strobe Torch

Our LED Strobe Torch has a single 1W LED with 120 lumens output (30% higher than our previous model).

The upgraded strobe unit is now silent-operating and has been further developed to surpass the performance of our previous model in colder water temperatures.

During operation, the strobe unit is visible up to 2 miles away (depending on conditions) and has a continuous burn time of up to 6 hours.

Manufactured from impact resistant ABS material, the one piece body features our newly developed (three position) external magnetic function. The unit is now depth tested to 50 metres.

LED. Flexi Light

High intensity LED that projects light through a flexible silicone stick.

The Flexi-Light has a simple press-to-operate button under the coloured marker, which activates flashing, constant and off modes.

Mode 1: Flash, 36h burn time
Mode 2: Constant, 20h burn time

Available with hook Velcro backing



Can be supplied with red and white diffusers and helmet mount

- Powerful 'spot' beam
- 8.5hr total continuous burn time
- NEW Philips Lumileds 3w Luxeon LED
- Depth tested to 95 metres
- Tough poly carbonate body with an aluminium torch head
- Double O-ring seals
- Rear mounted magnetic on/off switch
- Optional helmet mount
- 4 x AA alkaline batteries (supplied)

TORCH - MINI - LUX - ND



The re-designed battery carriage requires 3 x AA batteries (not supplied). Finally, the twin anchor points have been designed to fit up to 32mm webbing, and the unit is now supplied with a handy attached nylon wrist lanyard.

Features.

- Single 1W LED - 120 lumens output
- Upgraded 'silent' strobe unit
- Strobe visible up to 2 miles away
- Newly developed magnetic function switch
- One piece impact resistant body
- Twin attachment points
- Supplied with wrist lanyard

STROBE - LED - TORCH

THE SUPER ALTERNATIVE TO CHEMICAL LIGHTSTICKS



Infra-Red White Yellow Green Red Blue



- Simple push button operation
- Output: 8 lumens
- Visible distance: up to 3km
- Depth tested: 60 metres
- Double sealed
- Single use
- Non replaceable battery
- Material: RoHS compliant polyurethane

GLOWSTICK - LED - COLOUR

Accessories.

Stainless Steel / Titanium Knives & Weights



Helmet photographed supplied by Kirby Morgan Dive Systems, Inc.



120mm blade length

ALPHA TITANIUM

- Titanium MOD knife
- Ideal general purpose diving knife - designed for the military
- Super sharp
- Lightweight
- Positive lock mechanism
- Black plastic hard-case sheath

MOD - ITEM - 53 - KNIFE



75mm blade length

SQUEEZE LOCK

- Compact and portable safety knife
- Attaches to your BCD or PFD
- Allows for quick emergency access
- Patented locking mechanism
- Overall length 6.5"
- Blunt tip blade
- 304 series stainless steel

KNIFE - SQUEEZE LOCK



176mm blade length

GK ELITE

- Heavy duty commercial knife
- 7" X 2.5mm stainless steel blade
- Ultra sharp serrated edge
- High impact luminescent sheath
- Includes security shock cord
- Stainless steel split D-rings
- Twin aluminium Carabiner clips give multiple attachment options

KNIFE - GK - ELITE



75mm blade length

LDK RESCUE TITANIUM

- Titanium 75mm twin-edged blade
- 3mm chisel point safety blade
- Protective hard plastic sheath
- 'Push button' quick release catch
- Handle with rear anchor point
- Quick locate knife handle insert
- Variable width attachment system
- Bracket to attach 50mm webbing

KNIFE - LDK040



90mm blade length

SCISSOR KNIFE

- High quality 420 stainless steel
- Reduced risk of rusting
- 3.5" sharp tip blade with serrations
- 2 in 1 knife with scissor function
- Chromium plating on blades
- Compact quick-release sheath
- BC mounting kits are included

KNIFE-KN77-BLACK/GREY



110mm blade length

KN75 STAINLESS

- Serrated edge
- Net cutter
- Comfort grip handle
- Stainless steel solid butt
- O-ring holder
- Rubber knife straps

KNIFE - KN75 - COLOUR



110mm blade length

KN68

- General purpose knife
- 110 mm stainless steel blade
- Sharp and serrated edges
- Blunt chisel tip
- Comfort-grip handle
- Solid stainless steel butt
- O-ring holder.
- Hard plastic sheath / rubber straps

KNIFE - KN68 - COLOUR



78mm blade length

KN167

- 78mm twin edge blade
- 3mm chisel point safety blade
- Serrated/sharp edge and line cutter
- Hard plastic protective sheath
- 'Push button' quick release system
- Solid nylon comfort handle
- Webbing, BCD or PFD attachment
- Available in high-vis yellow or black

KNIFE - KN167 - COLOUR



70mm blade length

KN48

- 70mm twin edge SS blade
- Serrated/sharp edge and line cutter
- 2.5mm chisel point safety blade
- Protective hard plastic sheath
- Thumb-lock quick release system
- Comfort handle / rear anchor point
- Webbing, BCD, PFD, hose or rope attachments

KNIFE - KN48 - COLOUR



110mm blade length

KN65

- High quality 420 stainless steel
- 110mm sharp tip blade
- Serrated edge
- Line cutter
- 'Push button' quick release system
- Snap-lock hard plastic sheath
- Black soft-grip handle

KNIFE - KN65 - COLOUR



80mm blade length

KN166P WITH WEBBING SHEATH

- Single sided blade
- 2.5mm curve point safety blade
- High quality 420 stainless steel
- 80mm serrated blade
- Solid nylon handle with rear strike
- Soft webbing protective sheath

KNIFE - KN166 - CANVAS



LEAD SHOT (PER KG)

We sell shot weight by the kilo.

We can also supply mesh bags to contain your shot weight.

LEAD-SHOT



LEAD COATED WEIGHT

Individually plastic coated for corrosion protection. The weight block corners are smooth and rounded for additional comfort and feature twin weight belt webbing slots for use with standard diving webbing.

Available in 1kg, 2kg, 3kg and 4kg weights. Colour will vary dependant on weight required.

LEAD-BLOCK-KG-COLOUR



LEAD FILLED BAGS

3kg lead shot bags, using number 3 ungraphited lead shot.

Suitable for use with a BCD or our pouch weight belt.

MOD-ITEM-127-LEAD-SIZE



WEIGHTED LINE REEL

30 metres of 5mm cord with a lead weighted core.

Manufactured from 304-grade stainless steel, the reel frame also features a spring-loaded handle, anti-slip grip and an attachment point for an LED torch (available separately).

MOD-UWSB-REEL-WEIGHTED

NDB5 Range.

Military Holdalls

Our NDB5 bag range is constructed from PVC top spec material and is fully washable inside and out.

This strong and spacious holdall is ready for action across a wide range of diving scenarios. It's capacity should swallow up your bulky gear with ease.

These bags are renowned for their robust construction and durability making them the first choice for countless divers all over the world and are also supplied to the UK MOD who only use the best.

- Spacious main compartment
- D-zip opening with a weather protective zipper flap
- Internal mesh pockets
- Additional reinforcement on the base
- Comfortable top-mounted handle
- Four compression straps
- Webbing loops running down both sides of the bag – can be used with a carabiner or similar to attach items
- Adjustable and removable alpine-cut shoulder straps with an ergonomic fit
- Twin haul handles on either end
- Water-resistant, rugged design with extra bartacks and double stitching
- Washable inside and out
- Inner zipped nylon bag included
- Optional roll up changing mat*
- Available in blue, black and red
- Size options: 160L and 110L

160L NDB5 Holdall

Dimensions :
97cm length, 45cm width, 37cm height
Weight : 3.5kg

110L NDB5-S Holdall

Dimensions :
70cm length, 45cm width, 37cm height
Weight : 3kg

Scuba Holdall.

NDB10

- Designed for military use
- Hard-wearing Cordura®
- Separate end pocket
- Additional fin pocket
- Heavy duty top carry handle
- Padded shoulder strap
- Corrosion resistant zips
- Capacity: 74L
- Weight: 1.5kg
- Length: 73cm
- Width: 30cm
- Height: 34cm

 The NDB5 bag range is available in blue, red and black. Custom logos can be applied upon request. Additional fee may apply.



Inner dry clothes bag above is supplied with every NDB5 bag. Dimensions: 55cm length, 38cm width, 20cm height



All NDB5 bags have adjustable, removable alpine-cut shoulder straps. Please note the style of NDB5 bags may vary from photos shown.

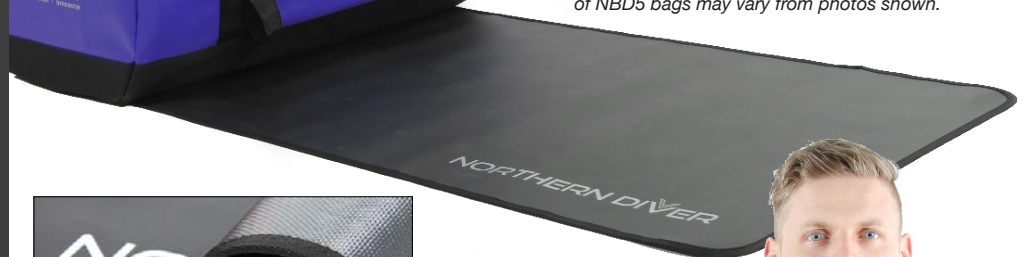

The bag range has been modified to include changing mat attachments so the mat can be rolled up and stored on the side of the bag when not in use. (Please note the 160L NDB5 blue military holdall does not include this feature).



Fully Dry Bags.

Air, Light & Watertight Range

YKK AQUASEAL ZIPPED DRY BAG

A large watertight and airtight bag weighing only 880g.

The Zipped Dry Bag is manufactured from 500 denier PVC and has welded seams for extra reinforcement. The YKK high compression Aquaseal dry zip is protected with PU tape.

The bag has adjustable, padded shoulder straps and is load tested to 100kg, including the lift strap between the shoulder straps. Can be fitted with inflation and exhaust valves.

Weight: 0.85kg
Width: 39cm Height: 62cm Length: 24cm

DRYBAG - ZIPPED

VOLUME : 60 L



VOYAGER ROLL TOP DRY BAG

Manufactured from a very heavy duty PVC backed Cordura® material, for excellent abrasion resistance. Bag also has a fully washable interior.

Features a roll-down top to keep the water out. The bag also keeps the water in if you are transporting wet items.

Includes a four-point compression strap system to reduce the height (if the bag is not filled to capacity).

Easy carrying, using the attached padded and adjustable rucksack straps or the top mounted webbing handle. Can be fitted with inflation and exhaust valves.

Weight: 0.7kg
Dimensions (expanded)
Width: 40cm Height: 75cm Length: 26cm

NDB6 - RUCKSACK - DRY

VOLUME : 78 L

ROLL TOP DRY BAGS

Made from heavy-duty PVC, with a roll-top quick release Fastex clip system to securely close and seal the dry bag and provide a convenient carry handle.

To seal the bag, simply roll the top over and clip.

Keeps the water out and will also keep the water in (if you are transporting wet items).

Available in three convenient sizes, to suit most watersports and many different outdoor pursuits.

The small size is perfect for stowing inside a canoe/kayak.

The medium and large sizes include a detachable shoulder strap, to assist with transporting a heavier load.

Available in small, medium and large sizes. 3 colour options.

Large: 0.7kg, Height: 75cm Width: 38cm Depth: 38cm
Medium: 0.4kg, Height: 54cm Width: 30cm Depth: 30cm
Small: 0.2kg, Height: 35cm Width: 20cm Depth: 20cm

LARGE : DRYBAG - L - COLOUR
MEDIUM : DRYBAG - M - COLOUR
SMALL : DRYBAG - S - COLOUR



Large - 117 Litres

Medium - 51 Litres

Small - 12 Litres

Travel Dive Bags. Voyager Range

10 year warranty against material and workmanship defects.

Did you know that the majority of bag damage occurs on baggage carousels at airports? If your bag is damaged in this way, contact the baggage handler and make a claim. Failing that, contact your holiday insurers.



Includes - Tablet Case, Security Gels and Cosmetics Bag and Luggage Tag

VOYAGER CABIN - IDEAL FOR RYANAIR AND OTHER LOW COST AIRLINES

- Ripstop nylon fabric
- Top-mounted 'comfort' carry handle
- Metallic red two stage telescopic handle
- 4 smooth wheels
- Shoulder strap - attaches to either side of the bag
- Generous main compartment with tablet pocket
- Northern diver tablet case included
- Velcro closing documents side pockets
- Discreet back zipped pocket - perfect for passport and wallet
- Boarding pass pouch on the rear
- Plastic clip inside to attach the security gels and cosmetics bag
- Length: 20cm Width: 38cm Height: 54cm

VOYAGER CABIN VOLUME : 40 L WEIGHT : 3KG



VOYAGER QUEST

- Ultra-durable Cordura® fabric
- Top-mounted 'comfort' carry handle
- 2 heavy duty wheels
- Extra-reinforced pull handle
- Lockable telescopic handle
- Zipped top fin compartment
- Zipped side and end pocket
- Rigid heavy duty PVC curved base
- Wheel and corner guards
- Coiled top corner guards
- Clamshell opening
- Length: 72cm, Width: 36cm, Height: 44cm



Includes - Luggage Tag and Wash Bag

VOYAGER QUEST VOLUME : 114 L WEIGHT : 5.4KG



VOYAGER MAXI QUEST

- Ripstop nylon fabric
- Top-mounted 'comfort' carry handle
- 2 heavy duty wheels
- Extra-reinforced pull handle
- Lockable telescopic handle
- Zipped top fin compartment
- Zipped side and end pocket
- Rigid heavy duty PVC curved base
- Wheel and corner guards
- Coiled top corner guards
- Clamshell opening
- 2 inside compartments
- Length: 81cm, Width: 39cm, Height: 44cm



Includes - Luggage Tag and Wash Bag

VOYAGER MAXI QUEST VOLUME : 139 L WEIGHT : 6.1KG

VOYAGER LIGHTWEIGHT



- Ripstop nylon fabric
- Top-mounted carry handle
- Handles at both ends
- Removable tow strap
- Protective PVC base
- Plastic runners on base
- Wheel and corner guards
- 2 zipped compartments
- Luggage tag window
- Length: 81cm, Width: 40cm, Height: 42cm



Includes - Wash Bag

VOYAGER LIGHTWEIGHT VOLUME : 136 L WEIGHT : 3.5KG



VOYAGER ALL TERRAIN LIGHTWEIGHT

- Washable PVC fabric
- Top-mounted carry handle
- Handles at both ends
- Removable tow strap
- Protective PVC base
- Plastic runners on base
- Wheel and corner guards
- 2 zipped compartments
- Luggage tag window



Includes - Wash Bag

L: 81cm, W: 40cm, Height: 42cm
VOYAGER ALL TERRAIN VOLUME : 136 L WEIGHT : 4.1KG

Regulators.

Cosmos Plus

EN250 cold water tested and CE approved

The Cosmos, a balanced and environmentally sealed regulator, is suitable for cold water and more extreme diving.

It is supplied in a padded regulator case with first/second stage, octopus second stage, first service kit and owner's manual.

ENVIRONMENTAL PROTECTION

The Cosmos is also suitable for dirty water.

The Cosmos first stage includes an environment sealing system - an end cap diaphragm seals the ambient chamber from the water.

SECOND STAGE

The Cosmos second stage can be adjusted by the diver in terms of sensitivity.

By rotating the adjustment control, the valve can work at maximum performance during a dive and can be set to a reduced sensitivity for other times when the valve is not being used for breathing, such as surface swimming. Includes LP hose and silicone mouth piece.

OCTOPUS

The Cosmos is supplied with a yellow octopus hose and second stage.

ANSTI Tested. Yoke A-clamp & DIN fitting compatible.

Also Available.

Service Kits

First service kit. When the time comes for the regulator's first service, you are prepared for an authorised service agent to carry out the task.

EN250 cold water tested and fully CE approved



COSMOS PLUS REGULATOR SET



COSMOS PLUS 2ND STAGE: REG-ND-2ND-P



COSMOS PLUS OCTOPUS: REG-ND-2ND-O



COSMOS PLUS 1ST STAGE: REG-ND-M50-DIN (or) ACLAMP



REGULATOR BAG: NDB14



REGULATOR SERVICE KIT

REG - ND - SERVICE - KIT



ACLAMP / DIN 1ST STAGE CONVERTORS

REG-ND-M50 ACLAMP (or) REG-ND-M50 DIN

Wrist Wear.

Digital Depth Gauge

Maximum operational depth : 100m

Depth accuracy : +/-2% of actual depth

Depth resolution : 0.1m

Time accuracy : 2 sec/day
Maximum dive duration : 5h

Data logging rate : 3 samples/second

Stored dive history : 20 data sets

Dive data download link : Optical serial through front panel

Display : 40 x 30mm single colour dot matrix OLED

Case : Machined aluminium and plastic wrist mount with flexible strap

Power source : Non-rechargeable Lithium battery with visual indication of remaining power

Battery replacement : Customer technician – no special tools

Battery duration :
Full brightness display : 20h continuous
Dim display : 30h continuous
Display off : 100h continuous
Standby : 1 year

Power switch :
Manual with default dim display brightness with auto power off



Rubber strap



Battery and pressure sensor slots



Single button operation

White colour OLED display with 170° viewing angle. Displays current depth - max depth - dive duration - dive duration exceeding max depth, with simple single button operation and adjustable screen brightness.

The device also saves a record of the dive, which can be transferred to a computer. Gauge settings can also be changed via a computer.

DIGI - DEPTH - GAUGE - ND000628

Addition.

Docking Station

The Digital Depth Gauge Docking Station can be used with the Digital Depth Gauge to change internal settings and extract dive log details.

After installing the software on a computer, data can be transferred via a USB cable.



DIGI-GAUGE-DOCKING-ND0000753

Accessories.

Consoles, Gauges & Hoses

All Gauges
Include Hoses



CLASSIC CONTENTS

0 - 450 bar contents gauge with built-in thermometer.

63mm face size.

Hose length 32"/81cm.

INST 1



CLASSIC CONTENTS AND DEPTH

Console includes a 450 bar contents gauge with built-in thermometer and 80 metre MDI depth gauge with calibration wheel. 63mm face size.

INST 3



CLASSIC CONTENTS, DEPTH AND COMPASS

2+1 console - 450 bar contents gauge with built-in thermometer, 80 metre MDI depth gauge, compass and bezel.

Hose length 32"/81cm. 63mm face size.

INST 4



HP HOSE HIGH PRESSURE

Northern Diver's high pressure hose. For use with our classic gauges.

Swivel end. Length: 31.5"/80cm

INST 15



COMPACT CONTENTS

A 400 bar compact contents gauge.

42mm face size.

Hose length 32"/81cm.

INST 10



COMPACT CONTENTS AND DEPTH

Compact console with a 400 bar contents gauge and 70 metre MDI depth gauge.

42mm face size.

Hose length 32"/81cm.

INST 12



COMPACT CONTENTS AND COMPASS

A compact console with a 400 bar contents gauge, compass and bezel.

42mm face size.

Hose length 32"/81cm.

INST 11



COMPACT CONTENTS, DEPTH AND COMPASS

Compact 2+1 console including 400 bar contents gauge, 70 metre MDI depth gauge, compass and bezel.

42mm face size.

Hose length 32"/81cm.

INST 13



WRIST DEPTH GAUGE

Copper-beryllium diaphragm wrist depth gauge with rack/pinion movement for smooth, precise operation.

Also includes a 340° scale, adjustable screw (for diving in altitude) and luminous dial. Available in imperial and metric. 63mm face size.

INST 6



WRIST COMPASS GAUGE

Classic style wrist compass with rubber strap and stainless steel buckle.

Includes a rotating bezel and sturdy housing.

60mm face size.

INST 5



A-CLAMP PRESSURE GAUGE CHECKER

232 bar high pressure contents indicator with push-button relief valve.

Attaches to cross flow valve to determine cylinder pressure. For surface use only.

INST 22

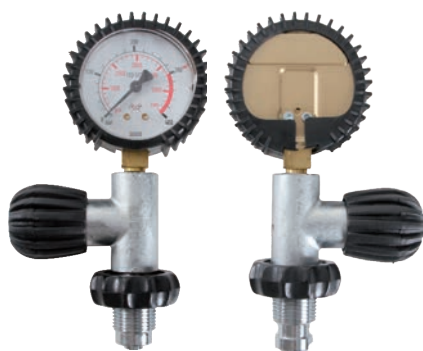

DIN PRESSURE GAUGE CHECKER

300 Bar DIN fitting high pressure contents indicator with push button pressure relief valve. Attaches to cross flow valve to determine cylinder pressure. For use with DIN fitting valves. For surface use only.

INST 22a



BAIL OUT HOSE WITH SWIVEL

An intermediate pressure hose that feeds an emergency supply of gas to into a diving helmet. Used mainly for commercial diving applications.

40"/102cm in length.

INST 18



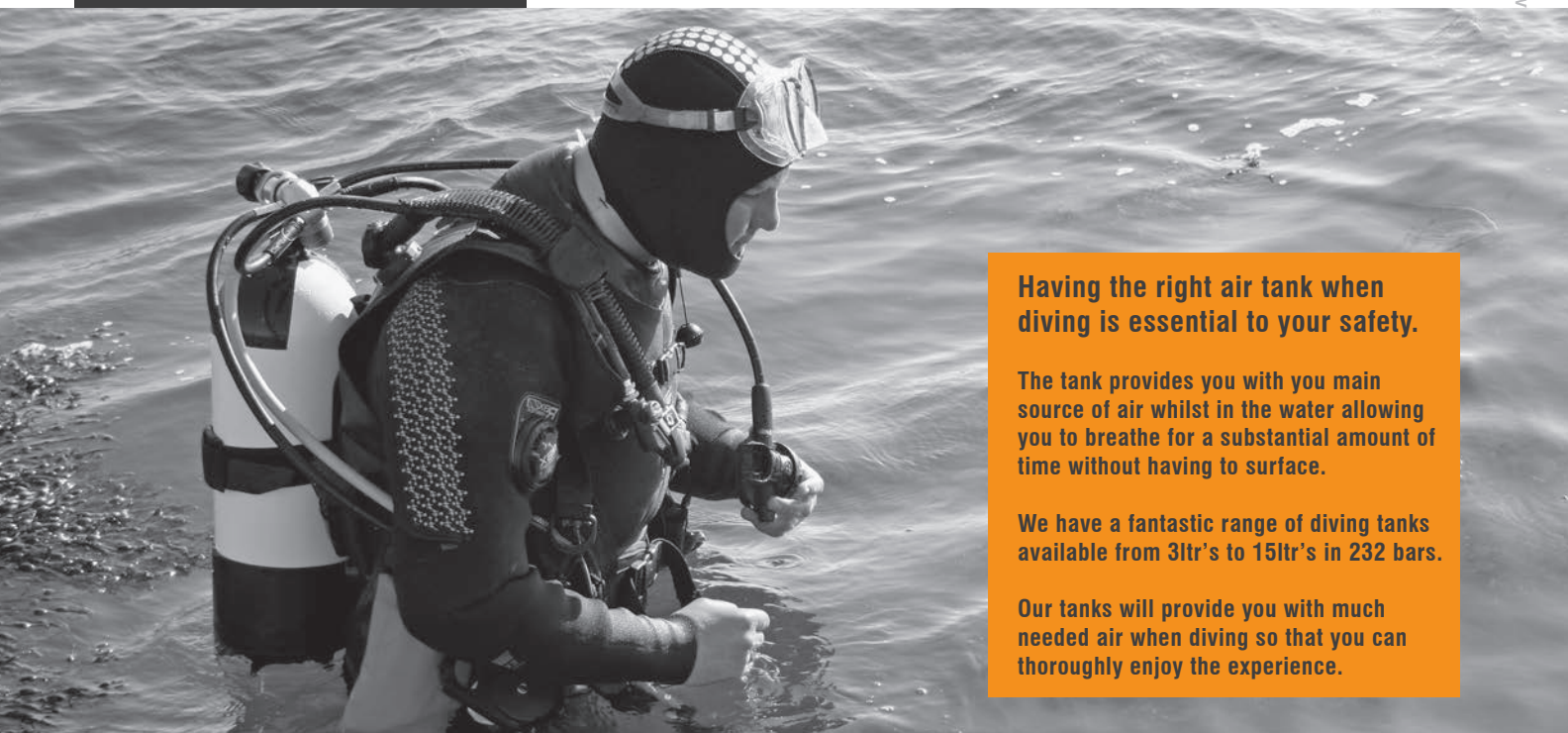

Having the right air tank when diving is essential to your safety.

The tank provides you with your main source of air whilst in the water allowing you to breathe for a substantial amount of time without having to surface.

We have a fantastic range of diving tanks available from 3ltr's to 15ltr's in 232 bars.

Our tanks will provide you with much needed air when diving so that you can thoroughly enjoy the experience.

Cylinders.

Faber

We supply all Faber steel diving cylinders with either a DIN or A-clamp (international) valve - compatible with all scuba diving regulators using these systems.

Faber cylinders can also be supplied O2 Clean (O2 serviced with an O2 clean cross-flow valve) and suitable for use with enriched air.

Faber cylinders are available in 3L, 7L, 10L, 12L and 15L sizes. 'Tall' and 'dumpy' variants are available for selected cylinders. Cylinder boots available for all sizes.

Faber's production cycle involves hot zinc spraying coupled with a primer and top coat of paint, which helps stop corrosion.

**Review

Great Cylinders..!
Marten on 13th Aug 2012

I purchased 4 12L cylinders (2 dumpy, 2 tall). I have made numerous dives with them and I am satisfied with the purchase.

Great product for the right price. I will probably buy one more, to use as a deco cylinder. I had them delivered to Sweden, took some time, but well worth the wait.



CYLINDER HANDLES

For easy carrying and moving of diving cylinders. Fits around the neck of 10L, 12L and 15L cylinders.

TANK HANDLE

15L 232 BAR CYLINDER

15 LITRE FABER

12L 232 BAR TALL

12.2LTR - CYLINDER - 232 - BAR

12L 232 BAR DUMPY

12.5LTR - CYLINDER

10L 232 BAR CYLINDER

10LTR - CYLINDER

7L 232 BAR CYLINDER

7LTR - CYLINDER - 232 - BAR

7L 300 BAR CYLINDER

7 LITRE 300 BAR FABR

3L 232 BAR CYLINDER

3LTR - CYLINDER

Cylinders. Accessories



CYLINDER BOOTS

Manufactured from a high grade rubber compound, these 'boots' are designed fit perfectly over the bottom of your steel cylinder, for impact protection and stability.

4" : CYLINDER-BOOT-15820 6" : CYLINDER-BOOT-15822
7" : CYLINDER-BOOT-15827 8" : CYLINDER-BOOT-15829

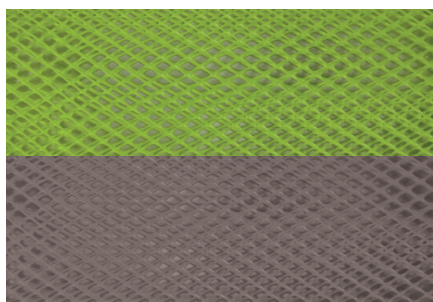

MESH CYLINDER PROTECTORS

Covers the cylinder's body.

2 sizes:
1 - 10L and 12L tall
2 - 12L dumpy and 15L

TANK-MESH-SIZE-COLOUR SIZE : 7" OR 8"



BACK PACK ASSEMBLY

Allows you to carry your cylinders like a backpack. The heavy duty nylon straps create a harness; the two shoulder straps spread the weight across your back.

BACKPACK HARNESS



CYLINDER CLAMP SYSTEM

One of the best systems of this type on the market. Engineered from anodised aluminium with stainless steel jubilee clips.

The two part quick release system is simple to use and securely clamps your pony cylinder to your main diving cylinder.

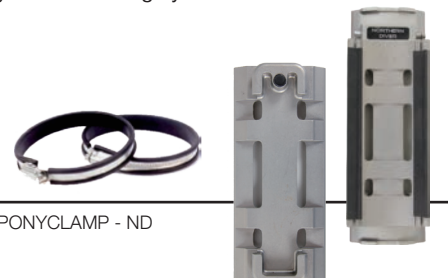

PONYCLAMP - ND

CYLINDER CHARGING ASSEMBLY

DIN CONNECTION SHOWN. ALSO AVAILABLE IN A-CLAMP

- G 1/4 hose connector - fits most UK compressor hoses
- Screw-type purge valve to release pressure once charging is complete
- Available DIN 240 bar and 350 bar versions
- Manufactured in accordance with PED 97/23/EC category of sound
- Engineering practice (SEP) & QMS ISO 9001
- Working pressure of 350 bar max
- Test pressure of 525 bar

N/A



Helmet photographed supplied by Kirby Morgan Dive Systems, Inc.



Test Equipment. Pressure Pots

The Pressure Pot is used to aid the leak testing of equipment.

As it has a polycarbonate window, it can also be used to check depth gauge accuracy.

Made from chrome plated mild steel, the Pressure Pot gives a maximum depth reading of 90m.

A Hansen quick-coupling inlet connection, quick-release 6 point locking mechanism and a straightforward display ensure simple and swift operation.



Features.

- Internal dimensions: 250 x 285mm
- Capacity: 14L
- Maximum inlet pressure: 9 bar
- Pressure relief valves: 10.35 bar
- Maximum depth reading: 90m
- Weight: 46.5kg
- Inlet connection: Hansen quick coupling
- Locking device: 6-point locking mechanism, quick release action
- Removable plastic liner

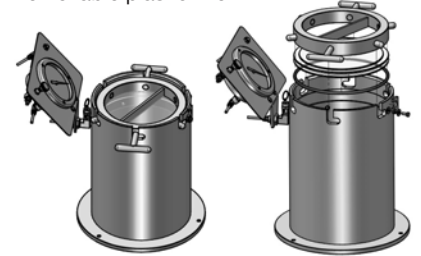

Analysers.

Inline Gas Analyser

Suitable for pre-use checks on compressed air cylinders and continuous monitoring for surface-supplied breathing gas.

The unit can be adapted to monitor additional gases, such as helium, carbon monoxide, carbon dioxide and propane. There is a built-in memory stick download port, which can be used to monitor equipment performance.

Operating temperature range:

- 20 to 50°C

Oxygen concentration range:

0.1% to 100%, accuracy +/-1%

Operating time using internal battery:

> 8 hours at 20°C, > 4 hours at - 20°C

Option for user-adjustable settings, including:

- Oxygen concentration alarm levels
- Calibration using any oxygen concentration
- LCD display brightness
- Automatic compensation for temperature and humidity
- Calibrated using ambient air
- Hi-lo oxygen concentration alarm, factory-set to lo = 19.9% and hi = 21.9%
- Audio and visual alarm
- Alarm mute button, resets after 30 seconds
- IP 65 rated enclosure
- Powered by a rechargeable battery
- 100V~240V AC
- Power supply / battery charger with 3-pin & 2-pin adaptors
- Battery protection circuit

Includes:

- Power supply/battery charger with adapters
- Hand priming pump for calibration
- Factory-set gas flow regulator for SSD systems
- Connection tube (flow regulator to analyser)
- Humidity sensor and gas conditioning circuit (unit is self calibrating)
- No requirement for a separate look up table



The analyser has the capability within the PCB to monitor helium, carbon monoxide and carbon dioxide.

There is also the provision to download the stored data by means of a USB.



MOD - GAS ANALYSER

Oxygen Analysers.

POMA

This oxygen monitor is designed to measure oxygen levels in the range 0.1 - 100%, for tank oxygen level verification.

The POMA is fitted with a large digital display and operates from an internal temperature compensated electrochemical oxygen sensor.

The unit is powered by a 9V battery, which will last for approximately 1 year before replacement is necessary. The oxygen monitor will automatically switch off after 10 minutes to ensure battery life is not compromised if the instrument is accidentally left turned on.

- Outlet pressure: 1.6 bar
- Working pressure: 200 bar
- Working temperature range: 0 to 45°C
- Sensor available as a spare part
- Swivel 0-275 bar gauge
- Bull nose or DIN fittings
- 5 year in-use service life
- Non PVC oxygen tube, 1.8 metres in length
- Push fit connectors at both ends
- Anti-kink internal filament
- Impact resistant dry carry case with high density foam inserts for extra protection
- Easily changeable O₂ sensor and battery
- Easy to calibrate from ambient air
- Comes with flow adaptor degrees
- Battery low warning indicator

Specification number: DC/
CPS/6596 issue 2

Manufactured in accordance with
BSEN 50270 and
BSEN 61000-6-3.



300 bar cylinder connector regulator to bleed off gas at low pressure for testing



Spares.

Oxygen Sensor

Average 3 year life from opening the tin.
Electrochemical transducers for measuring the oxygen partial pressure. Electrical connection via gold-plated slip rings. Output signal: 14-20 mV.
Response time $t(90)$: < 12 sec



Underwater Tools.

Cut - Off Saw

CO23

The CO23 Cut-Off Saw was designed for underwater use but it is also a very useful tool on land as well. The CO23 uses standard 10 inch (25.4 cm) diameter abrasive or wet or dry diamond blades for cutting metals or concrete.

Full data sheets are available contact us for further information.

N/A



- 10-15 gpm (38-57 lpm) operating range
- Adjustable depth shoe plate
- 3 inch (76.2 mm) deep maximum cut
- Wheel guard
- Integral HYREVZ™ gear-type motor
- Safety trigger

Underwater Tools.

Grinder

GR29

The Hydraulic GR29 Grinder is a right angle grinder ("vertical grinder") that can be used for grinding and cleaning in underwater applications with a variety of wheels, brushes and attachments.

The high torque gear motor drives a standard 5/8 - 11 threaded spindle.

A 9" adjustable wheel guard, two position assist handle and trigger guard are standard.

Painted hi visibility yellow.

A full data sheet is available contact us for further information.



- Integral Stanley Hyrevz gear motor produces high torque
- Stainless Steel spools and fasteners
- 2 position assist handle for right/left hand operation
- Oversized trigger with guard for diver comfort
- Adjustable wheel guard for infinite positions
- Plastisol covered handle for comfortable ergonomic grip
- Use with grinding wheels, hull scrubbing brushes, wire and nylon brushes, barnacle busters and Desmond wheels
- 3200 rpm @ 12 gpm
- Cast-in lifting eye

N/A

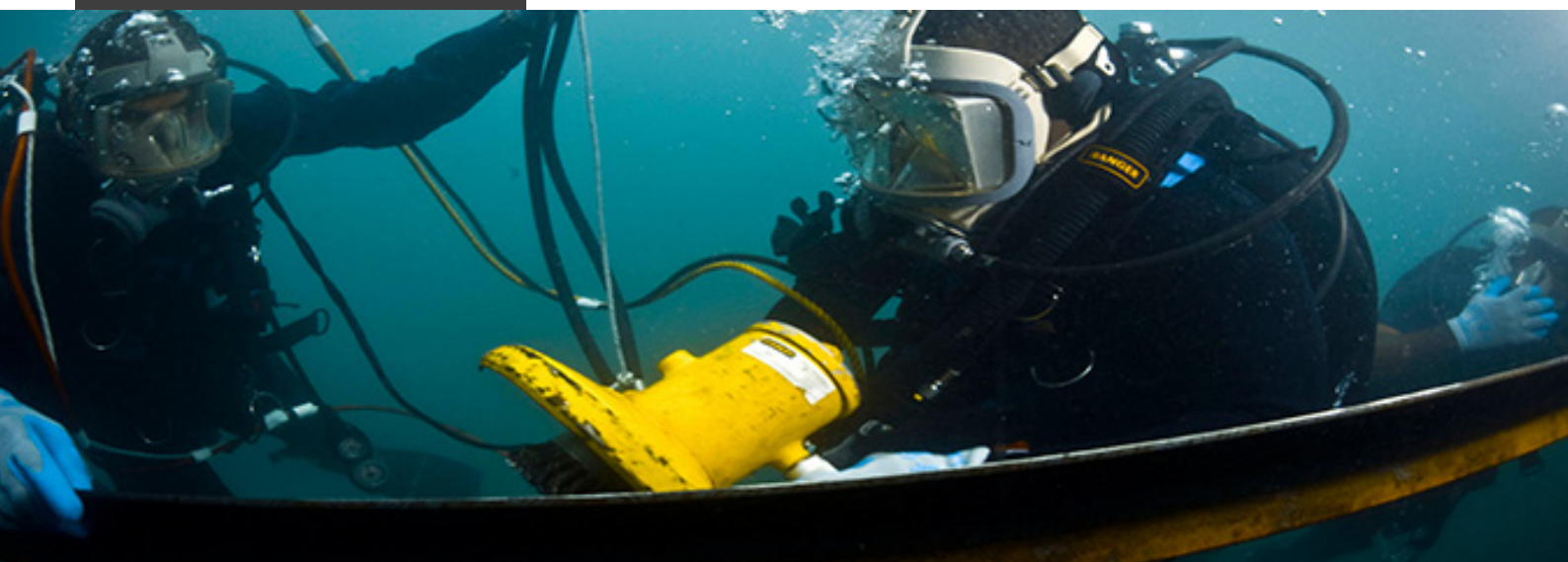

Underwater Tools.

Breaker / Driver

BR45, BR67, BR87

Underwater breakers are the trusted tool for several diving and underwater industries.

Stanley offers three sizes of breakers to meet application needs whether breaking concrete, coral removal, or rod driving.

Features:

- T-Handle with large on/off trigger for ease of use
- High visibility yellow paint
- Operates in any position

Full data sheets are available contact us for further information.

N/A



PRODUCT	SHANK SIZE	HEX LENGTH	HANDLE TYPE	FOOT
BR45320	1 in	4 in	T-Handle	Standard
BR67320	1 1/8 in	6 in	T-Handle	Standard
BR87320	1 1/8 in	6 in	T-Handle	Standard



Air Compressor.

CTP 150 - 200

- Output: 150L/min
- Speed: 1300rpm
- Max pressure: 350 bar
- Final pressure: 225/330 bar
- No. of stages/cylinders: 3/3
- Pressure maintenance valve
- Pressure relief valve on all stages



Bespoke options are available. If you require information on larger / other compressors not listed here, contact us.

Air Compressor.

CTP F 300 MOBILE

- Output: 300L/min
- Speed: 1850rpm
- Max pressure: 350 bar
- Final pressure: 225/330 bar
- No. of stages/cylinders: 3/3
- No. of filling connections: 4
- Central pressure gauge
- Thermal motor protection



LARS.

Diver Launch and Recovery System with cage

The LARS was designed to have a small footprint for easy transportation (It will fit in a 20 foot container) and so that it takes up minimal deck space when on ship.

IMCA DO18 and DO23 certification is provided with the system.

Specification

Base dimensions: 4 x 2m

Weight: 2.85 tons

Height (resting position): 7ft

Height (extended): 12ft

Electric motors: 20hp, 1440rpm, 440V, 3 phase, 60Hz

Pumps: 25Lpm at 2500psi

Oil tank capacity: 200L (100L independent tank for each winch)

Main A-frame tested to 1.5 tons

2 completely independent hydraulic power packs

Hydraulically operated rams for extending and resting the A-frame
2 hydraulic winches - one for basket and one for guide wire (main winch and guide winch)

Basket and guide weight, including emergency breathing apparatus for 2 divers

Main winch/guide winch set hydraulically for 1 ton, tested to 1.5 tons

2 brakes - non-rotating internal disc brake and automatic hydraulic hand brake

Hydraulic over centre valve with a direct drive hydraulic system

2 electric motors and pumps - 1 working, 1 standby

2 control boxes - 1 on the power pack, 1 on the platform

300kg clump weight with zinc anode

We can also supply LARS to custom requirements.

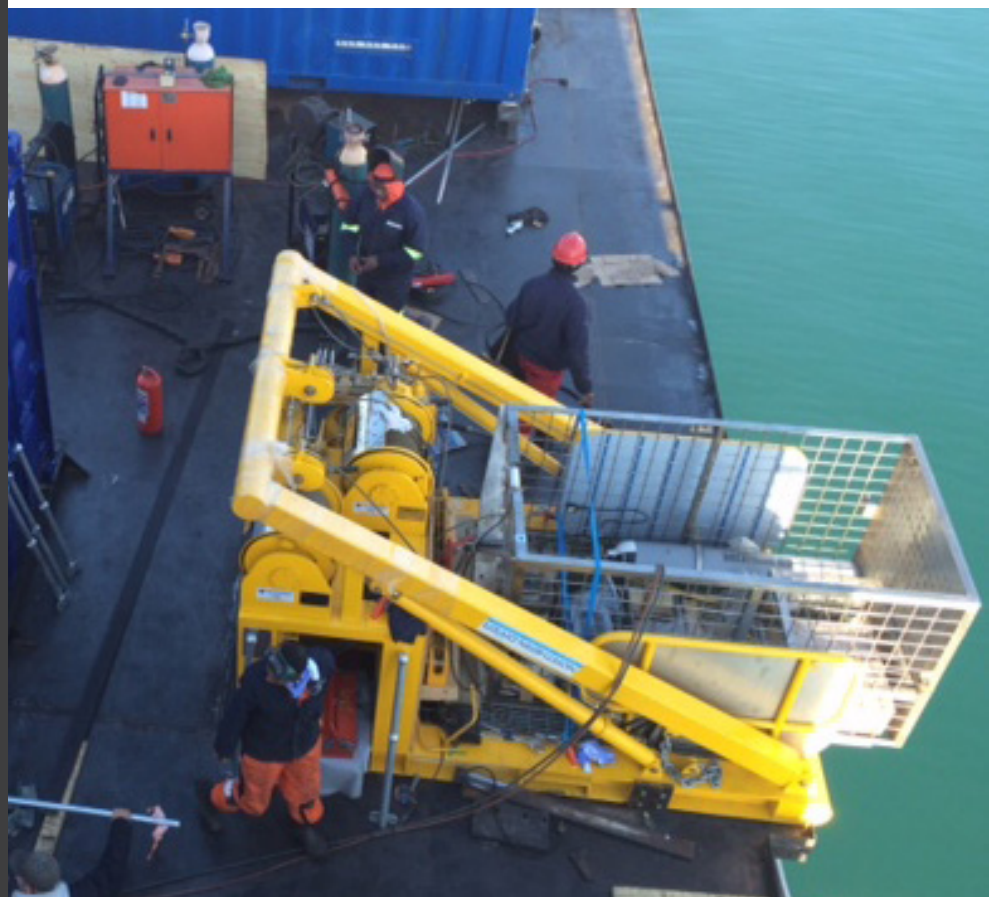

N/A

Panels.

Air Distribution Panel

(Photographed below)

SINGLE DIVER HP-LP AIR

DISTRIBUTION PANEL

- Engraved fascia
- 0 – 70m FSW 0.25% acc mirror scale depth gauge
- 2 HP 300 bar inlets
- LP 20 bar inlet
- Pneumo
- Needle valve
- LP ¼ turn valve
- 300 bar reducing regulator Peli or wall-mounted case supplied

OTHER SIZES AVAILABLE ON REQUEST



2 DIVER RADIO WITH BUILT IN CHARGER

NSN: N/A

Hand-held push-to-talk microphone Audio power output: 20W per channel

Frequency response: 500Hz to 3kHz Dimensions: 25.4 x 22.9 x 36.8cm

Weight: 9.98kg approx Power: 110/220V AC 50/60Hz (automatic sensing) or rechargeable batteries

N/A



Custom Built. Chambers

We can custom build recompression chambers to clients' requirements.

Contact us to discuss your specification.

Tel: +44 (0) 1257 25 69 49

Email: neil@ndiver.com

N/A



ALB.

Air Lifting Bags

We can supply or rent a full range of IMCA approved lifting bags - parachute style, totally enclosed or gel filled for precision control.

Bags and lifting systems are available worldwide to either purchase or lease.



AIR LIFT BAGS (ALB)

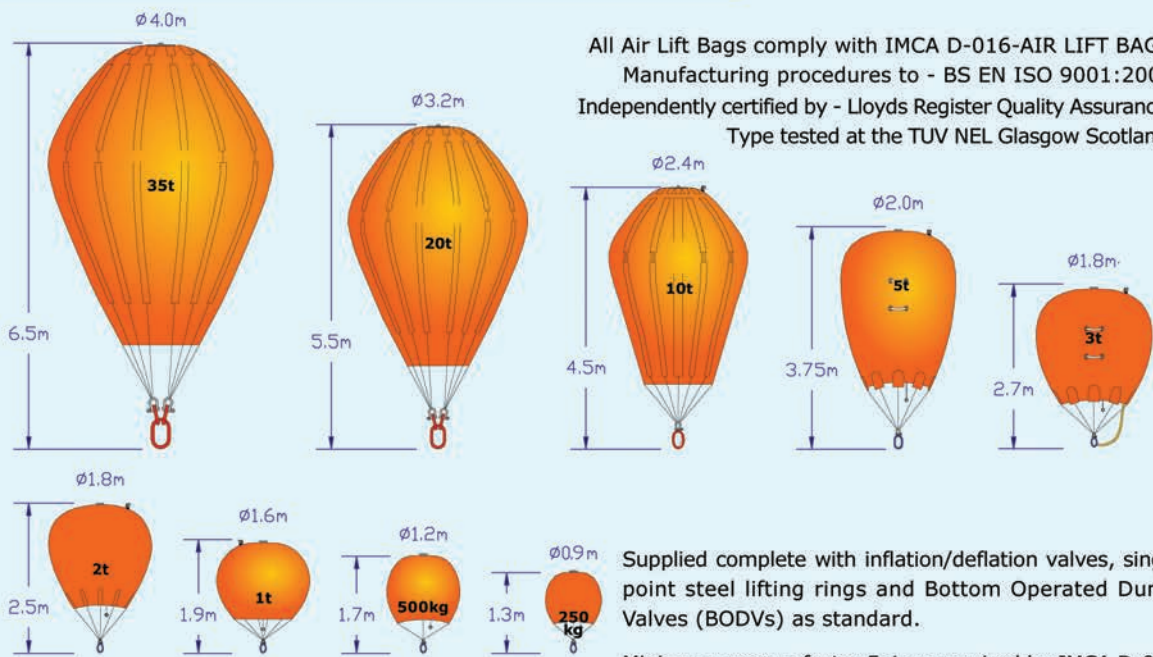

All Air Lift Bags comply with IMCA D-016-AIR LIFT BAGS Manufacturing procedures to - BS EN ISO 9001:2008 Independently certified by - Lloyds Register Quality Assurance Type tested at the TUV NEL Glasgow Scotland

Supplied complete with inflation/deflation valves, single point steel lifting rings and Bottom Operated Dump Valves (BODVs) as standard.

Minimum reserve factor 5:1 as required by IMCA D-016

INFLATABLE BUOYANCY UNITS (IBU)

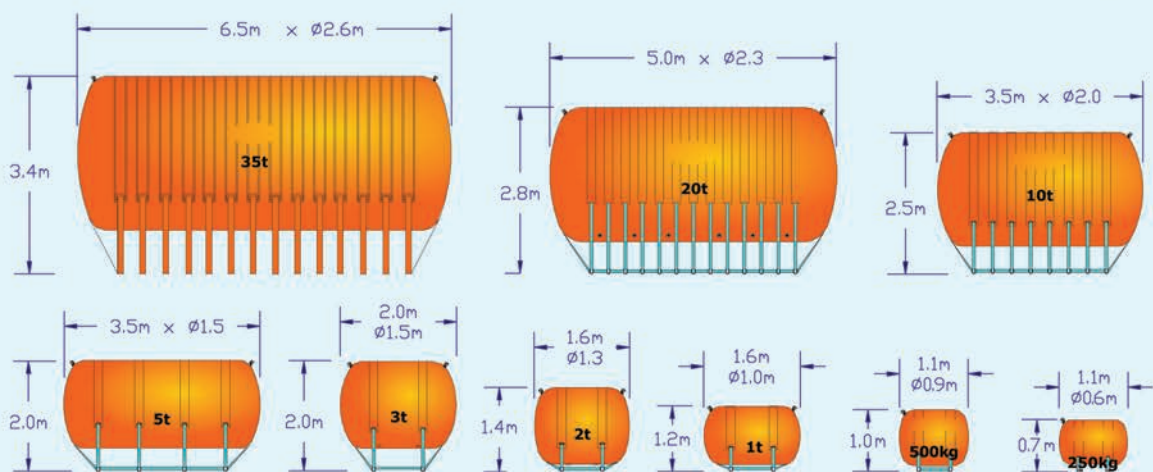

Inflatable Buoyancy Units comply with IMCA D-016-AIR LIFT BAGS Manufacturing procedures to - BS EN ISO9001:2008 Independently certified by - Lloyds Register Quality Assurance

Supplied complete with inflation/deflation valves, multiple steel lifting rings and Pressure Release Valves (PRVs) as standard.

Minimum reserve factor 5:1 as required by IMCA D016

DTI - 300 A

Diver Acoustic Receiver



The DTI-300A is a small battery-operated acoustic receiver that tracks and locates underwater acoustic beacons and a unique family of acoustic transponders. It is ergonomically designed and displays navigation data via an LCD display. Sealed switches allow the diver to access the control and utility functions of the receiver.

When operating in passive mode, the DTI-300A can locate standard acoustic beacons that operate from 25-40kHz. The DTI-300A display guides the operator with signal strength and bearing to the selected acoustic beacon. A built-in electronics compass gives additional directional support in keeping the diver on course.

The DTI-300A can also track and locate transponders designed to work with the receiver. These transponders, ATT-400, allow divers to mark targets underwater and relocate them up to 1000 metres away. Once an ATT-400 has been interrogated, the DTI-300FN gives accurate range and bearing to the transponder - to within 1 metre. Because the ATT-400 can be programmed to operate on eight different channels, the DTI-300A can relocate eight different locations simultaneously.

Passive mode	
Receiver bandwidth	- 25 to 40kHz in 1kHz increments
Active mode	
Transmit frequency	- 26kHz
Receive frequency	- 27,28,29,30,31,32,33,34 kHz
Acoustic output	- 180dB
Acoustic signal	- Coded
System range	- 1000 metres
Electronic compass	
Accuracy	- <0.5 to 1.5° RMS
Repeatability	- ± 0.3°

Display	- LCD
Graphic user Interface	- Range or signal strength Compass bearing Bearing indicator to target channel indicator Low battery
Battery	- Rechargeable
Operational life	- 6 hours
Control switches	- Sealed piezo-ceramic
Depth rating	- 100 metres
Housing	- Delrin
Size	- 30 x 16 x 9.5cm
Weight	- In air: 2.9kg - In water: -0.185kg

N/A

DPR - 275.

Pinger Receiver Location Systems



The DPR-275 diver-operated pinger receiver is intended for use in hostile marine environments. Used by both military and commercial customers worldwide, the DPR-275 can track and locate any underwater acoustic beacons operating between 5 and 80kHz.

The DPR-275 can be converted to operate from the surface quickly by removing the hydrophone on the unit and attaching it to the adjustable surface hydrophone assembly. The hydrophone's sensitivity allows the operator to swiftly and effectively navigate a vessel to any beacon source. Converting the DPR-275 back to a diver configuration completes the recovery operation.

The PRS-275 pinger receiver system consists of the DPR-275 diver pinger receiver, surface hydrophone housing, staff assembly, underwater headset and carry case.



Frequency range:	5 to 80kHz
Bandwidth:	1kHz
Sensitivity:	80dB
Hydrophone directivity:	Typically 30° at 3dB limits
Transducer beam pattern:	30° at 27kHz, 25° at 37.5kHz
LCD display:	Frequency and low battery indication
LED display:	Signal strength
Power source:	Two alkaline C cells

Battery life:	30 hours
Hydrophone staff assembly:	PVC, length 152cm
Hydrophone cable length:	6m
Operating depth:	200m
Weight in air:	2.9kg
Weight in water:	190g
Housing material:	Corrosion resist aluminium
Housing dimensions:	Length 24.8cm, diameter 11.4cm

N/A

Seeker Acoustic. Directional Receiver



The Seeker acoustic directional receiver is a small, rugged passive pinger receiver, used to assist operators of ROVs and AUVs in tracking acoustic sound sources (from 25 to 40kHz).

There are two different models of Seeker receivers. The VADR1000M operates to depths of 1000 metres and the VADR6000M can withstand depths of 6000 metres.

Pinger receiver mode:

Receive bandwidth:
25 to 40kHz in 100Hz increments
Receiver sensitivity:
-100dB ref 1uPa @ 1 metre

Transporter mode:

Receive frequencies:
27, 28, 29, 30, 31, 32, 33, 34kHz
Interrogation frequency: 26kHz
Acoustic output: 180dB re 1uPa @ 1m
Acoustic signal: Coded system Range: Up to 1000m

Directional hydrophone:

Beam width: 40° + 5°
BINS: Left or right, 3, 8, 20 or >20°
Bearing accuracy: 4° nominal in BINS 1 and 2
Bearing resolution: 2°

Control interface:

RS232: 9600 baud, no parity, 8 data bits and 1 stop bit
Connector: 5 pin underwater pluggable
Interface software: Microsoft OS, provided
Input voltage: 18 to 32V DC, 24V DC nominal

Mechanical / environmental:

Housing: Aluminium hard coat anodised
Depth rating:
VADR1000M: 1000m
VADR6000M: 6000m
Weight:
VADR-1000M: 3.8kg in air, 3.2kg in water
VADR-6000M: 6.8kg in air, 5.5kg in water
Dimensions:
VADR-1000M: 11.4 x 26.0cm
VADR-6000M: 12.7 x 28.0cm
Operating temperature range: -18 to 43°C

N/A

ULB - 364 Series. Underwater Location Beacons

The ULB-364 underwater location beacon is a cost effective acoustic relocation pinger, designed for rigorous offshore use. Using off-the-shelf 9V alkaline or lithium batteries, the ULB-364 is ideal for marking underwater sites or equipment when cost is a factor.

The ULB-364 can be ordered to meet unique needs, with options for different frequencies, acoustic outputs and activation methods.

The ULB-364EL Extended Beacon is the right choice when deployment lengths are longer than 5 months. A longer housing, which holds four additional 9 volt batteries, extends the operational life of the ULB-364EL to 11.5 months.



Frequencies: 27, 37, 45kHz

Acoustic output: 0.125, 0.5, 2W

Pulse length: 5ms

Pulse repetition: 1 pulse/sec

Activation: Battery installation

Power source: 2x 9V alkaline / 2x 9V lithium

Operating depth: 1250m

Housing material: Aluminium

Dimensions: Length: 32.25cm Diameter: 6.35cm

Battery life:

9V Alkaline: 0.125W - 150 days, 0.5W - 45 days, 2W - 16 days

9V Lithium: 0.125W - 350 days, 0.5W - 130 days, 2W - 48 days



N/A

ULB - 350 Series. Underwater Beacon

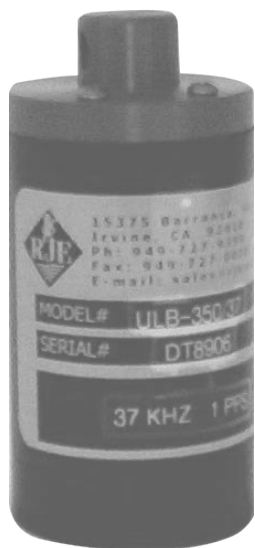

The ULB-350 underwater beacon is a compact, rugged and reliable acoustic signalling device used for marking equipment and underwater sites. Ideal for applications when size and weight are an issue. The ULB-350 can be ordered in many configurations in terms of acoustic power output, frequency, and time delay. Using an off-the-shelf 9 volt battery adds the advantage of cost-effective maintenance. The ULB-350 continuously sends out an acoustic signal for up to 40 days.

Operating frequency: 9 or 45kHz +/- 1kHz
Acoustic output: 163dB at 1m
Pulse repetition rate: 1 pulse per second
Pulse length: 10ms
Activation: Water switch (other options available)
Power source: 9V alkaline or lithium battery
Operating life: 20 days with alkaline battery, 40 days with lithium battery
Operating depth: 1216m
Weight: 217g
Housing dimensions: Length: 7.9cm, diameter: 4.3cm
Options: Factory-set frequencies from 9 to 45kHz. Time delays from 1 minute to 3 months Extended operational life.

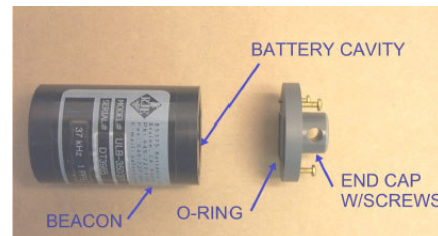

* Specify at time of order. Note: non-standard frequencies and acoustic power outputs available.

Digital. Tactical Swim Board Bringing combat swimmers into the 20th Century.

- 100m depth rated
- Battery life : 10hours (other option available upon request)
- 5" LCD display
- 540 x 540 resolution
- Digital depth, time, stop watch, compass and gyroscope
- Material : Aluminium. Machined from a single billet
- Anodized hard black
- Adjustable handles to aid visibility and swimming position
- Ergonomically designed buttons for use with or without gloves



N/A

TAC-100.

Combat Swim Board



The TAC-100 Underwater Navigation Board is the original navigation platform used by professional divers around the world. The TAC-100 integrates an underwater compass onto a rugged and lightweight high impact plastic console with easy-to-grip handles.

The underwater compass utilises a black compass card with luminous markings to indicate heading. Internal lubber lines keep the diver on course. A built-in adjustable chem light holder on the console illuminates the compass for night ops.

The TAC-100 offers different instrumentation options and comes with a padded carrying bag. Two options are offered for instrumentation packages. The DG100 is a rugged digital depth gauge and timer that tracks both depth and time in one compact package. The second option is an analogue depth gauge and dive chronometer. Both options offer effective solutions for accurate navigation during critical dive situations.

TAC100-1 Navigation Board

Size of board: L 30.5cm
W 25.4cm
H 12.7cm
Weight in air: 3lbs (1.35kg)
Board material: Black ABS
Compass illumination: Adjustable chem-light

Analogue Depth Gauge

Imperial model: 0 to 200ft
Metric model: 0 to 60m
Max depth maker resettable tell-tale
Face luminous white, black numerals

Dive Chronometer

Casio G-Shock watch with lap timer

TAC100-2 Underwater Compass

Compass card bearings: 5° markings
Illumination: Up to 8 hours
Compass card tilt: 20°
Size: D 10cm
H 9.5cm
325g weight in air

N/A

TAC-300.

Combat Swim Board



Smaller and lighter than the TAC-100, the TAC-300 integrates a highly accurate compass and a digital depth gauge/timer on to a rugged plastic board.

To maintain bearing position and accuracy, the TAC-300 uses the BENS C1150 underwater compass. The large compass dial, with advanced luminous properties, makes navigating easy - even in the poorest visibility. In addition, an electronic "V-Lite" illuminates the compass to ensure high visibility of the compass heading. Diver depth, total dive and surface intervals are tracked in the DG100 digital depth gauge and timer.

To protect the TAC-300, a protective sock is integrated into the attached lanyard. Designed by combat swimmers for combat swimming, the TAC-300 is the complete package to meet your mission needs.

TAC300 Combat Swim Board

Size of board: L 25.5cm
W 17cm
H 6.3cm
Total weight in air: 1.2kg
Board material: PEP
Compass illumination: Electronic "V-Lite"
Compass card bearings: 10° markings
Illumination: Up to 8 hours
Compass card tilt: 40°
Size: D 122mm
H 72.5mm
Weight in air: 400g
Depth rated: 70m

DG100

Depth range: 0-100m
Depth tolerance: +/- 1% of full scale
Depth resolution: 0.1ft/0.1m
Altitude compensation: 1828m
Display: Red LED
Dive timer tolerance: ± 1%
Leg timer functions: Start/pause/reset
LED timer duration: 99 hours max
Battery: Rechargeable lithium
Battery life: 300 charges
Operational life: 35 hours
Operating temperature: -2 to 42°C
Housing: Anodised aluminum
Depth rated: 100m
Dimensions: 50 x 50 x 25mm

Dive Chronometer

Casio G-Shock Watch with lap timer

N/A

Peace Of Mind.

Why ?



Find Us Online.

View our extensive product range

www.ndiver-commercial.com

www.ndiver-commercial.com

It's simply really, because we are trusted by the best.

The ability to supply absolutely anything diving related has resulted in Northern Diver equipment being used by Commercial, Fire & Rescue and Military teams including over 30 countries and more than 1,000 businesses worldwide.

Despite our current extensive product range, the main catalyst to our success has derived from our ability to manufacture bespoke products to each individual customer's specific requirements.

This has been the result of working closely with the end user in order to understand requirements for their unique working conditions.

All our equipment is manufactured to appropriate **CE approval** or the required industry standards.

Northern Diver adopts an environmentally responsible attitude, focusing attention upon key principals such as Environmental Legislation, Management System, Communication, Resources and Materials and the Operation of the Business as well as being approved by ISOQAR to perform in house.

In the unlikely event you encounter any issues with the equipment we supply to you, we will have a representative sent out immediately, without any hesitation.

This kind of service, along with our impeccable quality, great fitting and comfortable dry diving equipment has helped with the acquisition of our 7 ongoing Military contracts worldwide.

We have designed and manufactured a range of products to the M.O.D for 8 years, constantly being welcomed with the news that we are the most reliable suppliers to date.



Retail

Our equipment is trusted by the best. Cross-sector technical expertise means we consistently launch innovative products for sport divers.

www.ndiver.com



Military

We are the prime contractor to the UK Ministry of Defence for drysuits and diving equipment. Our military diving hardware is also used by numerous friendly nations.

www.ndiver-military.com



Rescue

We supply over 200 organisations across the UK and overseas. We manufacture and stock a wide range of drysuits and equipment, which are available for immediate delivery in an emergency.

www.ndiver-rescue.com



www.ndiver-commercial.com



Contact Us

Office: +44 (0) 1257 25 69 49, Website: www.ndiver-commercial.com

Neil Tordoff - Commercial Sales Director

Mob: +44 (0) 7972 061 533, Email: neil@ndiver.com

Nathan Durrington - Commercial Consultant

Mob: +44 (0) 7932 792 060, Email: nathand@ndiver.com

Northern Diver International Ltd., East Quarry, Appley Lane North, Appley Bridge, Wigan, Lancashire, UK, WN6 9AE